



OWNER'S MANUAL VOLVO 164

VOLVO 164

Operating Instructions • Description • Servicing

This owner's manual deals with all the variations of the Volvo 164 with model year designation A.

It contains all the information you need to be able to drive and service your vehicle in the best possible way. By following the instructions contained herein you will find that your Volvo will come up to all the expectations concerning economical operation and excellent performance that you have every right to expect of a top-quality vehicle.

This is not intended to be a comprehensive technical manual and does not claim to make the reader a perfect car mechanic.

It will, however, show you how to look after your vehicle so that trouble in the future can be avoided. The better you know your Volvo, the better service it can give you. Even for an experienced motorist it can contain some valuable information.

For a more detailed mechanical description and repair procedures, we refer you to the special Service Manual for the car which can be purchased from the dealer.

The specifications and constructional details given in this book are not binding. We reserve the right to carry out modifications without previous notice.

AB VOLVO • GÖTEBORG, SWEDEN

Reproduction permitted if source quoted

CONTENTS

INTRODUCTION

Volvo Service Organization	3
Warranty and Service Booklet	3
Service Inspections	3

OPERATING INSTRUCTIONS

Instruments and controls	4
Interior and body	14
Starting and driving	21
Running-in	21
Starting the engine	22
Gear-changing	23
Towing	26
Braking	27

TECHNICAL DESCRIPTION

Engine compartment	28
Engine	29
Power transmission	31
Front end and steering	33
Electrical system	33
Brakes	36

SERVICING

General	37
Maintenance scheme	38
Lubrication	40
Oil changes	41
Engine	44

Electrical system	49
Power transmission	54
Brakes	54
Front end	54
Wheels and tyres	55
Body	57
Long-distance trip	60
Cold weather	60
Lubricating chart	68

FAULT TRACING

When the engine stalls	62
------------------------	----

SPECIFICATIONS

Type designations	63
Measurements and weights	64
Engine	64
Electrical system	66
Power transmission	66
Front wheel alignment	67
Wheels and tyres	67
Capacities	67
Tools	67

INDEX	70
-------	----

WHEN FILLING THE TANK	72
-----------------------	----

INTRODUCTION

Warranty and Service Booklet

A warranty and service booklet accompanies each vehicle when it is delivered. This booklet contains a coupon entitling you to a service inspection after 2 500 km (1 500 miles). If possible, let the dealer who supplied the vehicle carry out this service inspection. Any of our dealers, however, can do this if required.

If our six-month guarantee is to apply, we make one absolute condition and that is that the above-mentioned inspection is carried out at roughly the mileage shown and that the vehicle has been looked after in accordance with the instructions given in this book.

Service Inspections

After the 2 500 km (1 500 miles) service inspection has been carried out, you should come to some arrangement with your dealer concerning continued, regular service inspections in accordance with the suggestions made in our Service Book. Thorough and regular servicing is of vital importance for the performance and length of life of the vehicle.

Always use genuine Volvo parts.



Volvo Service Organization

To get the most out of the invested capital represented by a car, it must be looked after and serviced regularly. Volvo has gone to a great deal of trouble in the design and selection of material to ensure that the car in question only requires a minimum of servicing. We rely, however, on your co-operation with regard to the future maintenance of your vehicle. To help you with this, Volvo has built up a world-wide service organization. All Volvo dealers have specially trained personnel and receive a continuous supply of technical information from the Volvo Service Organization concerning repairs and adjustments. They also have special tools,

designed at the Volvo factory. Moreover, all Volvo dealers have a comprehensive stock of parts which is your guarantee that you get genuine Volvo components. That is why our dealers are in the best possible position to give your vehicle first-class service concerning both maintenance operations and repairs. You should also refer to your dealer for any information about your Volvo that is not included in this instruction book.

Not only has Volvo a workshop within call in your own country: it has also a widely distributed service network in other countries.

OPERATING INSTRUCTIONS

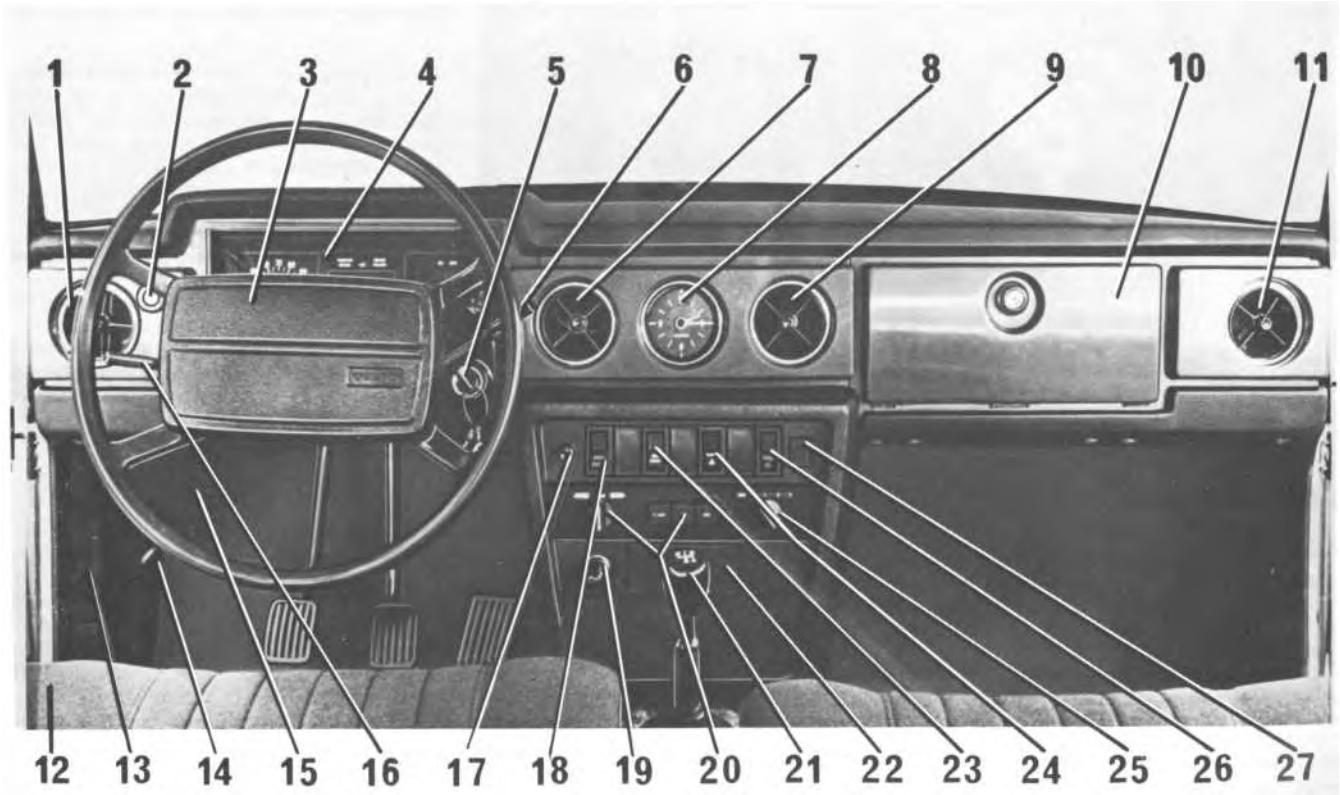

INSTRUMENTS AND CONTROLS

- 1 Air vent
- 2 Headlight switch
- 3 Horn
- 4 Combined instrument
- 5 Ignition switch and steering wheel lock
- 6 Lever switch for windscreen wipers/washer
- 7 Air vent
- 8 Clock
- 9 Air vent
- 10 Glove locker
- 11 Air vent
- 12 Parking brake
- 13 Fusebox (fuse change, see page 53)
- 14 Air-vent control
- 15 Bonnet release
- 16 Lever for turn indicators, mainbeams/dipped beams and mainbeams flasher
- 17 Instrument panel light switch
- 18 Foglight switch
- 19 Cigarette lighter
- 20 Heater/ventilation controls
- 21 Gear lever
- 22 Ashtray
- 23 Switch for elec. heated rear window
- 24 Switch for emergency warning flashers
- 25 Fan switch
- 26 Switch for air conditioning (optional)
- 27 Fasten seat belts light

The instruments and controls are described in more detail in the following pages with a reference to the numbers in the picture opposite. Note that variations may occur between different markets.

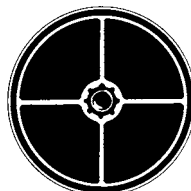

1, 7, 9, 11 Air vents

Air is blown into the compartment through the four air vents from the heater system fan. The amount of air thus supplied by the vents can be regulated by the switch 25 for the fan. Warm air can also be distributed to the upper part of the compartment. Turning the button in the middle of the vents 1/4 turn anti-clockwise shuts them off. The vents can be pivoted to point to any desired place in the compartment. The two outer vents can be aimed at the side windows on the front doors for rapid demisting.

OPERATING INSTRUCTIONS

2 Headlight switch



The headlights are operated by means of a push-pull type switch on the dashboard as well as a lever (16) on the steering column.

All the lights are extinguished when the lighting switch is pushed fully in. Pulling it out to the half-way position, switches on the parking lights, and when it is fully out, the fullbeam or dipped headlights are switched on depending on the position of the lever (16).

Since the lighting system is not connected across the ignition switch, the lights will function irrespective of whether the ignition key is in position or not.

3 Horn

The horn is sounded by depressing the impact pad in the centre of the steering wheel while the ignition is switched on.

OPERATING INSTRUCTIONS

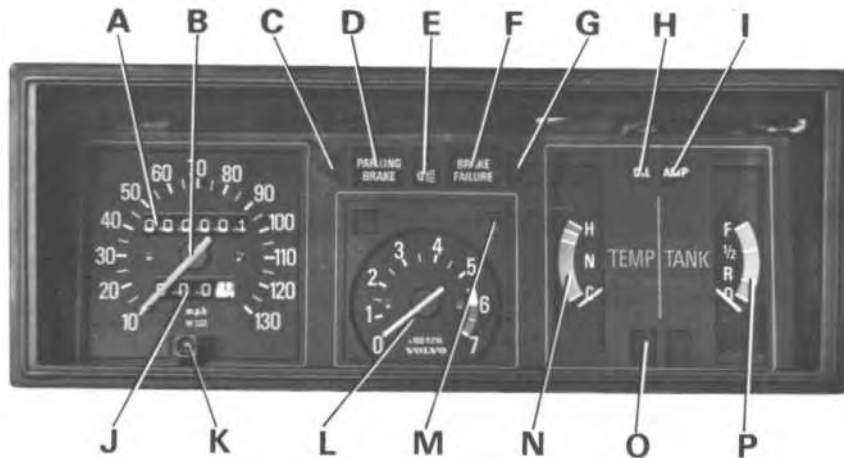

4 Instrument panel

- A Mileometer
- B Speedometer
- C Control light, turn indicators (green)
- D Control light, parking brake (red)
- E Control light, fullbeam headlights (blue)
- F Warning light, brake circuits (red)
- G Control light, turn indicators (green)
- H Warning light, oil pressure (red)
- I Warning light, battery charging (red)
- J Trip meter
- K Trip meter reset button
- L Rev counter
- M Bulb integrity sensor (yellow)
- N Temperature gauge
- O Control light, overdrive (green)
- P Fuel gauge

A Mileometer



The mileometer shows the total distance covered in miles. After 999999 miles it returns to zero and starts to go round again.

D Control light, parking brake

**PARKING
BRAKE**

This lamp gives a steady red light when the parking brake is applied and the ignition switched on.

F Warning light, brake circuits

**BRAKE
FAILURE**

It also functions as a warning light should one of the brake circuits fail. If the light goes on during driving, the car should be driven without delay to a workshop for a check on the brake system.

Observe due care when driving under such conditions.

H Warning light, oil pressure

OIL

This lights red when the engine oil pressure is too low. When the ignition is switched on, the light should go on and then go out again when the engine starts. Never start driving until the light goes out. If the light goes on during driving, stop the engine and find out the reason for this. In most cases it means that the oil level is too low. After hard driving it may happen that the warning light comes on when the engine is idling. This is normal providing it goes out again when engine speed is increased.

OPERATING INSTRUCTIONS

I Warning light, battery charging



This lamp gives a steady red light when the battery is discharging. Should it light during driving, either there is some fault in the electrical system or the fan belt is not sufficiently tensioned and is thus slipping on the alternator pulley, causing poor charging.

L Rev counter

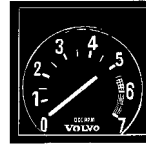

The rev counter indicates the engine speed per minute. The amber-coloured area between 5500 and 6000 rpm is the range which is momentarily permitted for example, during rapid acceleration. The speed range 6000-7000 rpm is marked in solid red and must not be used.

J Trip meter



The trip meter measures distances of up to maximum 999 miles. The window furthest to the right shows tenths of a mile and is therefore useful for measuring short distances.

K Trip meter reset button



The trip meter is reset to zero by pushing in the button.

M Bulb integrity sensor



This lamp gives a steady yellow light if any of the bulbs for the dipped headlights, rear lights or license plate light do not function. If a brake light bulb does not work, the warning lamp will go on each time the brake pedal is depressed. When the ignition is switched on, the lamp should light and then go out when the engine starts.

N Coolant temperature gauge



The temperature gauge shows the temperature of the coolant and thus indicates the working temperature of the engine. The gauge pointer should normally remain within the green sector.

During town driving and idling when the weather is particularly warm, the temperature gauge pointer may enter the amber-coloured field.

Should the pointer repeatedly point to the solid red field, the coolant and fan belt tension should be checked.

O Control light, overdrive



The lamp gives a steady green light when the overdrive is engaged. Concerning engaging and disengaging overdrive, see page 23.

OPERATING INSTRUCTIONS



P Fuel gauge

The fuel gauge is graduated "full", "half", "reserve" and "empty". The red field between "reserve" and "empty" is a reminder that the tank should be filled. When the gauge is on "reserve", there are approx. 8 dm³/litres (2 Imp. galls) in the tank. The gauge pointer registers when the ignition is switched on.



5 Combined ignition switch and steering wheel lock

The switch has four positions: (0) Locking position, (I) Intermediate position, (II) Driving position and (III) Starting position. The key can be taken out of the lock only in the Locking position. Removing the key automatically locks the steering wheel.

With the key in the Intermediate position, the steering wheel is unlocked and certain electrical components are switched on.

To start the engine, turn the key to the Starting position. This engages the starter motor. As soon as the engine starts, release the key which automatically returns to the Driving position.

If the car is parked in such a way as to make it difficult to unlock the steering wheel, unlocking can be made easier by slightly turning the steering wheel one way and then the other.

When the ignition is switched on but the engine is not started, the following warning lamps light:

- Warning lamp for oil pressure
- Warning lamp for battery charging
- Bulb integrity sensor
- Warning lamp for parking brake
- Warning lamp for brake circuits

This enables us to check whether these warning lamps are functioning or not. When the engine starts the lights should again go out (does not apply to the warning light for the parking brake when the parking brake is on).

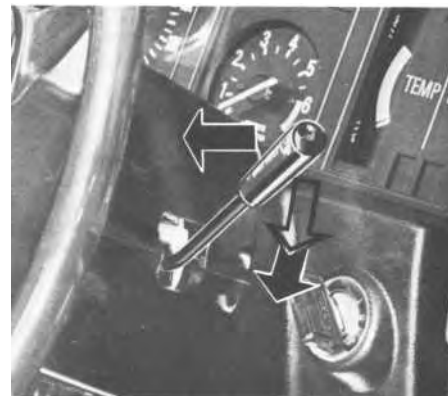

6 Lever switch for windscreen wipers/washer

The windscreen wipers operate at two speeds. If the lever is moved down one step, this operates the wipers at normal speed. With the lever pushed down all the way, the wipers operate at full speed.

The windscreen washer is engaged by pulling the lever towards the steering wheel. The washer can also be used even when the wipers are not engaged.

Concerning adjustment of the washer nozzle, see page 73.

The fluid container is located in the engine compartment and holds about 5.8 dm³/litres (5 qts.)

OPERATING INSTRUCTIONS



8 Clock

The clock is operated electrically. To reset it, push in the re-set knob and turn the hands.



12 Parking brake

The parking brake lever is on the outside of the driving seat and operates on the rear wheels only. When the parking brake is applied and the ignition is on, a red control light (4 D) on the instrument panel goes on.



15 Bonnet release

The bonnet lock is released by pulling out the handle situated to the extreme left under the dashboard. This releases the bonnet which is still retained by the safety catch.

14 Air vent control

Pushing the control forwards opens a fresh-air vent on the driver's side. Note the fan should not be operating if cool air is desired through this vent.

OPERATING INSTRUCTIONS



The bonnet is opened by inserting the fingers under the front edge and pressing up the catch as shown in the picture. Check that the bonnet locks properly when closed.

The location of the bonnet when closed can be adjusted if necessary by screwing in or out the rubber plugs underneath the bonnet at the front end and on the mudguards below the windscreen.

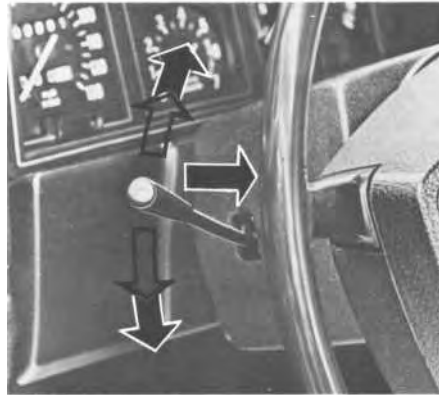

16 Switch lever for turn indicators, dipped headlights and headlight flasher

The switch lever on the left-hand side of the steering column just below the steering wheel controls the turn indicators, dipped headlights and headlight flasher. The switch has a so-called "stop point" for changing lanes. In other words, when changing lanes or passing, move the switch up or down to the stop point and hold it there with the hand. The respective indicator should start blinking. When the lever is released, it automatically returns to neutral. When making a turn, move the lever past the stop point as far as it can go. It will return to neutral when the steering wheel straightens out the car again. To switch from main beam to dipped beam and vice versa, move the lever towards

the steering wheel and then release. Here the lighting switch (2) should be pulled fully out.

The lever is also used for flashing with mainbeams when the headlights are not switched on. The headlight flasher functions by moving the lever towards the steering wheel and it remains in function until the lever is released.

17 Instrument panel light switch



Turning the knob clockwise or anti-clockwise increases or dims the lighting for the instruments.

OPERATING INSTRUCTIONS

18 Switch for foglights



Depressing the lower part of the rocker switch turns on the foglights, providing that the parking or dipped headlights are on. Because of legislation, the foglights are wired for certain markets across the parking and fullbeam headlights or only across the parking lights.

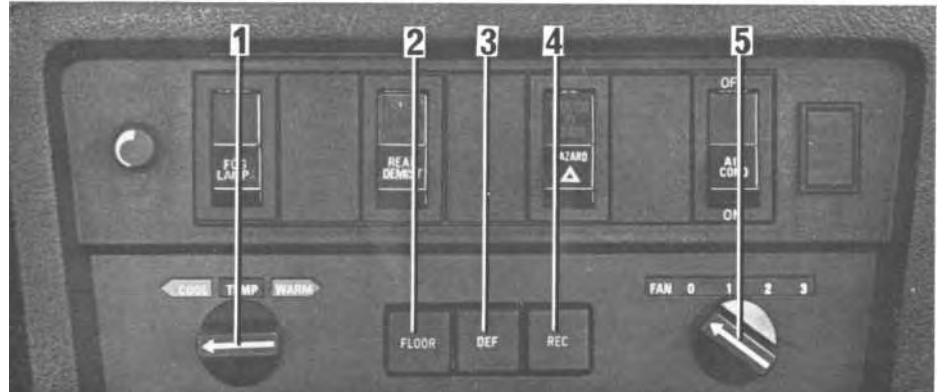

19 Cigarette lighter



To use the cigarette lighter, push it in. The lighter releases automatically when it attains sufficient heat.

20 Heater/ventilation controls

The heating system is a combined warm air and fresh air system which can be obtained with or without air conditioning being installed. The controls for the system are as follows:

1. TEMP
2. FLOOR
3. DEF
4. REC
5. FAN

and to some extent the four air vents, (see page 5).

1. TEMP regulates the temperature of the incoming air.

Knob anti-clockwise = cool
Knob clockwise = warm

2, 3, 4 standard adjustments are made by means of the push buttons FLOOR, DEF and REC.

No buttons pushed in: No air to floor and very weak defroster effect. On the other hand, however, air can also be obtained through the four air vents.

Only FLOOR pushed in: Full air flow to front and rear floor and weak defroster effect.

Only DEF pushed in: Full defroster effect and no air to floor.

OPERATING INSTRUCTIONS

The REC button is intended to be used in combination with air conditioning (optional equipment) and should not be used for heating purposes.

5. FAN regulates the fan's speed.

Knob at 0 = fan switched off

Knob at 3 = full fan output (This speed is primarily intended to be used in combination with air conditioning.)

For maximum possible temperature rapidly:

TEMP fully clockwise

FAN to position 2 (only in extreme cases use position 3)

Only FLOOR pushed in

Air vents half-open

This adjustment, however, provides less defroster effect.

To avoid or rapidly remove mist on windows:

TEMP fully clockwise

FAN to position 2 (only in extreme cases use position 3)

Only DEF pushed in

The outer air vents half-open

When starting a car covered with snow, clean off any snow over the air intake to the car heater in order to avoid misting inside.

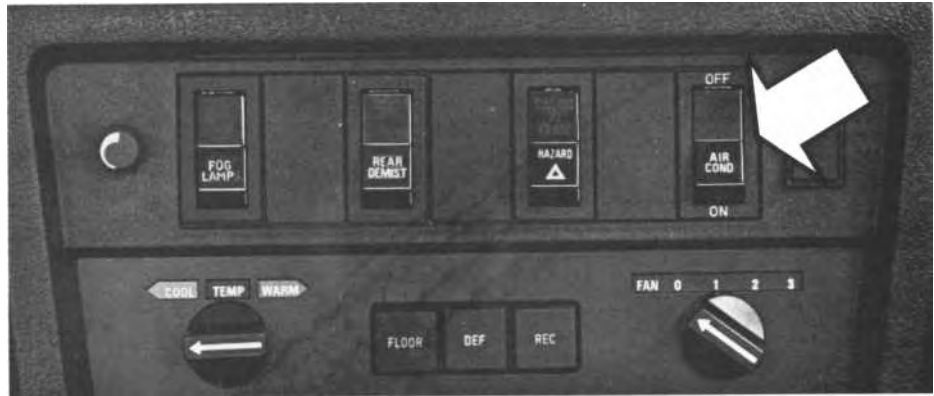

26 Air conditioning (optional)

The air conditioning is operated with the following controls:

1. Switch on the air conditioning compressor with switch AIR COND.
2. Turn control TEMP to COOL (fully anti-clockwise) for rapid cooling. Then adjust to a suitable temperature.
3. Push in button REC for rapid cooling. When a suitable temperature has been obtained, REC does not need to be pushed in.
4. Select a suitable fan speed with FAN.

To get the best cooling effect, all the car windows should be closed and the push buttons FLOOR and DEF not pushed in.

Most of the cooled air will then enter the compartment through the four air vents on dashboard. These, of course, must be open.

A tip: For rapid removal of mist inside the car, the air conditioning can suitably be used at temperatures where normal cooling is not desired. Proceed as follows:

1. Push in AIR COND
2. Push in REC
3. Adjust FAN to position 3
4. Adjust to desired temperature with TEMP

Let the air conditioning system run for several minutes a couple of times a month even during the wintertime to enable the compressor seals to be lubricated. Let a Volvo workshop check the air conditioning each year.

OPERATING INSTRUCTIONS

23 Switch for electrically heated rear window



The Volvo 164 has a rear window fitted with electrical heating in order to remove any mist during cold and damp weather.

The heating is by means of wires on the inside of the rear window. Avoid placing anything near the wires that might damage them and avoid wiping the inside of the rear window since there is risk of rings, etc., on fingers damaging the wires.

To switch on the rear window heating, push in the lower part of the switch. Switch off once the rear window is clear of mist and ice in order not to overload the battery unduly.

24 Switch for emergency warning flashers



All the four warning lights start flashing simultaneously when the lower part of the switch is depressed. A warning lamp mounted in the switch blinks in unison. The warning lights are not connected across the ignition and thus function irrespective of whether the ignition is switched on or not. Pushing in the upper part of the switch will switch off the warning flashers. These should only be used when you have to stop the car where there is possible danger to other traffic. Note that regulations governing the use of these lights may vary in different places.

27 Fasten seat belt light



A fasten seat belt light goes on if the car is driven and the driver and front seat passenger have not fastened their seat belts. The warning lamp goes on when the ignition is switched on. As soon as the driver and, if present, the front seat passenger, fasten their seat belts between the seats, the light goes out.

OPERATING INSTRUCTIONS

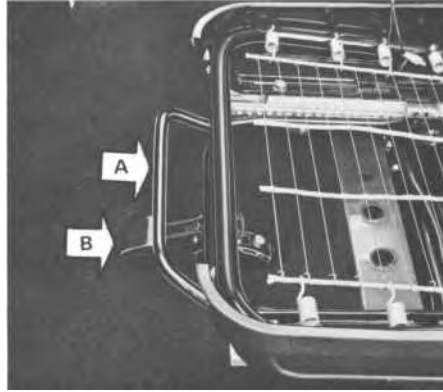

and the backrest of the driver's seat are electrically heated. A thermostat for the heater element in the cushion and backrest which cuts in the current when the temperature goes below +14°C (57°F) and cuts out at +26°C (79°F). The electrical heating only functions when the ignition is switched on.

INTERIOR AND BODY

Front seats

Backrest adjustment

The front seat backrest is adjusted with the knob on the outside of the backrest (see picture).
The backrest can be folded backwards to a comfortable rest or repose angle.

Length and height adjustment driver's seat

The driver's seat can be adjusted forwards-backwards by lifting loop handle A upwards. Exert leverage with your feet on the floor and slide the seat to the desired position. Adjustment is made vertically by lifting lever B upwards and then setting the seat to one of the height positions. If necessary, the seat can then be adjusted lengthwise. On certain markets both the seating cushion

Head restraints

The front seats are provided with adjustable head restraints. If the head restraint is to fulfil its function properly, correct adjustment is important, that is, it must support against the head and not only against the neck. After adjusting, lock the head restraints by turning the plastic nuts clockwise

OPERATING INSTRUCTIONS



Lumbar support

The front seats are provided with an adjustable lumbar support. This is operated by means of the knob on the right side of the backrest. To tension the lumbar support, and thus exert more pressure against the small of the back, turn the knob clockwise, "FIRM", and to relieve the pressure against the small of the back, turn the knob anti-clockwise, "SOFT".



Length and height adjustment front passenger's seat

The front passenger's seat can be adjusted forward-backwards by pulling up the lever underneath at the front of the seat. Vertically the seat is adjustable to three different positions. Remove the seat cushion to get at the bolts in the seating bracket. Remove the two bolts holding the seating frame to the seating brackets. Place the frame in the desired position and re-fit the bolts in the suitable holes.



In connection with this adjustment, it may be desirable or necessary to adjust the inclination angle of the entire seat. This is done with the eyelet bolt at the front under the seat frame. Remove the bolt which goes through the eyelet screw and fold the seat backwards. Then release the locknut in the floor of the car and adjust the eyelet screw to the desired position. Re-lock the eyelet screw securely with the locknut.

OPERATING INSTRUCTIONS



Seat belts

Always use the seat belt for all types of driving. Remember that it is possible even in slow city traffic to incur serious injury from sudden, unexpected stopping.

As a reminder to fasten the seat belt, a light on the instrument panel goes on if the driver attempts to drive off without first having fastened his seat belt, see page 13.

Automatically retracting inertia seat belts

To fit the belt, pull out the webbing slowly. If the webbing is pulled out too quickly, the emergency-locking retractor reacts and locks the belt. Normally the seat belt re-

tractor is "unlocked". The belt locks if the webbing is pulled out too quickly or if the car is braked suddenly or is at an angle of more than 10-15° or when taking a sharp bend.

Should the webbing lock when being pulled out, slacken off slightly and then continue pulling out more slowly. Place one strap round the waist and the other across the shoulder - chest and secure the belt by pushing the buckle tongue into the locking slot in the lock between the seats. An audible clicking sound is a sign that the belt is locked.

Make sure that the webbing fits comfortably across the body and is not twisted.

The belt is released by depressing the red button in the locking device. Make a habit of letting the roller roll up the webbing on removing the belt.

Note that small children (up to 8-10 years or not exceeding 30 kg/66 lb.) should not use the seat belts. Use instead a special safety seat for children. This seat is placed on the front passenger seat with its back to the dashboard. Contact your nearest Volvo dealer for more information on this.

OPERATING INSTRUCTIONS



Manual safety belts

If the belt requires lengthening, first slacken the upper section of the belt and take hold of the adjusting piece with one hand and pull out the lap strap to the desired length. Tidy up belt slackness by pulling in the upper part of the double section.

If the belt requires shortening, pull in the upper part of the lap strap's double section. After a certain amount of practice, all adjustments can be carried out with the one hand. The belt is released by depressing the red button.



Safety belts in rear seat

As standard, the rear seat is fitted with anchorages for safety belts.

Servicing

Hang up the belt in the place intended. Check to make sure that the belt is not clamped or frays against sharp edges. Now and again check to make sure that the anchorage bolts are well tightened and that the belt is otherwise in good condition.

Use water and an approved synthetic detergent for cleaning the belts. If a belt is exposed to violent stretching, for example, in connection with a collision, it should be replaced even though it may appear to be undamaged. Also replace a belt if well worn or damaged.

Never modify or repair a belt on your own, but have this done by a Volvo workshop.

OPERATING INSTRUCTIONS



Doors and locks

The car is fitted with a lock and keyhole on each of the front doors.

The front doors can be locked from the outside by pushing the lock button on the window ledge down and shutting the door while keeping the outside handle pulled out as shown in the picture. To lock the rear doors it is not necessary to keep the door handle pulled out.

Do not leave the keys in the car.

All the doors can be locked on the inside by pushing down the lock button on the window ledge. On the front doors this lock button lifts automatically when the door is opened from the inside. On the rear doors, however, the lock button must first be pulled up before the doors can be opened from the inside. This is an advantage if children are in the rear seat.

Note that the front doors are not better closed by pushing down the lock button on the inside. Doing this only prevents the door from being opened on the outside. During driving, the lock buttons should not be pushed down, since this could prevent the doors being opened on the outside in the event of an accident.

The door locks have been designed with a view to providing maximum possible protection against freezing during the winter time. As an extra measure, however, you should lubricate the locks regularly during very cold weather with a suitable anti-freeze agent. If the lock is already frozen, be careful not to break the key in the lock. Instead, heat the key and immediately place it in the lock. This should unfreeze the lock. Should you lose the car keys, contact your nearest Volvo dealer for new ones and quote the code number of the keys which have been lost.

OPERATING INSTRUCTIONS



Child safety lock

On the inside of the rear door at the very back there is a small red button. When this button is moved down to its lower position (A) and the door is closed, the door cannot be opened from the inside, but on the other hand from the outside if the lock button on the window ledge is not depressed.

With the red button in the upper position (B), the rear door lock functions normally.

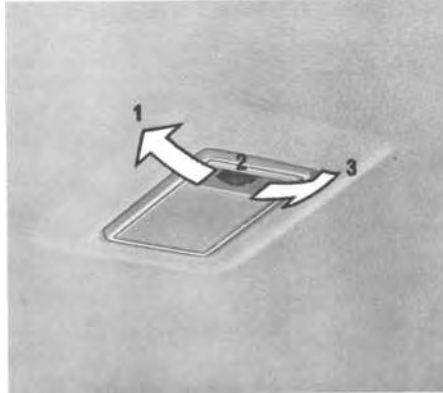

Interior lighting

1. The light is always on.
2. The light is always off.
3. The light comes on when either front door is opened.

Cars fitted with sun-roof have another type of glass cover for the interior light.



Sun-roof

The sun-roof is opened and closed by a crank handle. When not in use, the handle is folded in the recess in the roof between both the sun visors.

To close the sun-roof, wind it forwards fully, then wind back the handle a little and fold it into the recess in the roof.

OPERATING INSTRUCTIONS



Rearview mirrors

The inside rearview mirror can be switched to anti-dazzle by pushing back the knob. On certain markets the car is provided with exterior mirrors which can be adjusted up and down by the actual mirror and side-ways by the mirror arm.

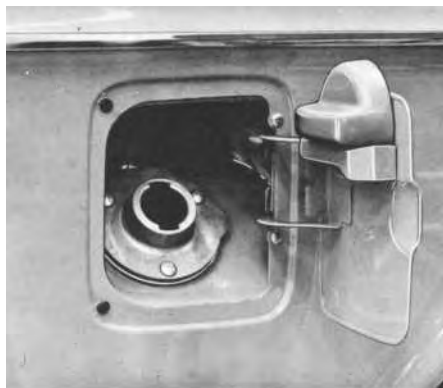

Fuel tank

The fuel tank filler cap is located on the right rear mudguard. When filling the tank, the tank cap can suitably be placed in the bracket on the inside of the cap, see picture.

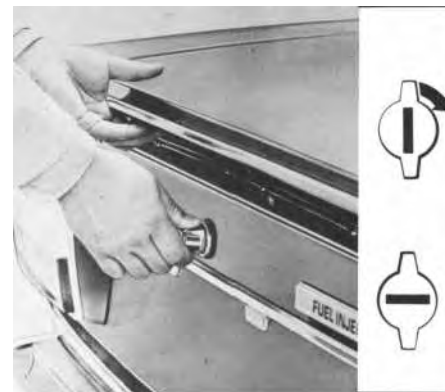

Luggage compartment

The luggage compartment is locked with the same key as that used for the doors. The lid is opened by turning the handle clockwise and lifting the lid up at the same time. Note that the key must be removed from the lock in order to turn the lock knob. The lid is balanced and will remain stationary in its opened position. The spare wheel is securely held in position to the left in the compartment by a strap, which also holds in position the jack and tool kit.

OPERATING INSTRUCTIONS



STARTING AND DRIVING

Running-in

When the vehicle is new, we recommend that a certain amount of caution be observed during the running-in period, for it is during this time that the movable part of the car must be properly bedded in so as to obtain smooth and durable sliding surfaces. The maximum permissible speed, therefore, should not be exceeded

	below the first 1000 km (600 miles)		between 1000 and 2000 km (600 and 1200 miles)	
1st speed	30 kmph	(20 mph)	50 kmph	(30 mph)
2nd speed	55 kmph	(35 mph)	75 kmph	(45 mph)
3rd speed	80 kmph	(50 mph)	100 kmph	(60 mph)
4th speed	110 kmph	(70 mph)	130 kmph	(80 mph)

Avoid driving at low speed in high gear and using the kick-down (on vehicles with automatic transmission) during the first 2000 km (1200 miles).

Running-in inspections

After 2 500 km (1 500 miles) the vehicle should be taken to a Volvo workshop for the warranty inspection. Included with the checks and adjustments then made is a change of oil in the engine, transmission and rear axle. It is very important to ensure that this oil change is carried out since during the running-in period the engine oil usually collects a lot of impurities. Subsequent oil changes should be carried out at approximately those intervals indicated in the maintenance scheme on page 38 and in the lubricating chart at the end of the book.

Before being delivered, all Volvo engines are test-run on test benches and in the vehicles on test tracks. We are therefore assured that all clearances are satisfactory and we thus accept no responsibility for damage caused by careless running-in.

OPERATING INSTRUCTIONS

Before your first drive

Before you begin driving your new Volvo, we would advise you to become familiar with the vehicle and the various instruments and controls used during driving. When you are comfortably seated with the seat belt fastened and are acquainted with the location of the the various controls, you are ready to begin driving.

Start the engine (injection, B 30 E and B 30 F) as follows:

1. Check that the parking brake is on and the gear lever is in neutral (position N or P, autom. transmission).
2. Always make a habit of depressing the clutch pedal until the engine starts.
3. Turn the ignition key to the starting position. Release the key as soon as the engine has started.

Note. If the engine is cold, do not depress the accelerator pedal until the engine has started. If the engine stops, start it again without depressing the accelerator pedal.

If the engine is warm, the accelerator pedal should be pressed down about half-way. Avoid repeated short attempts at starting. (In the case of each new attempt, the starting valve functions and causes fuel to be injected into inlet duct.) Instead, allow the starter motor to operate for a rather longer time (but not more than 15-20 seconds) each time.

Never rev an engine immediately after starting from cold.

Starting in garage

Before starting your car in a garage, always open the garage doors. The exhaust gases from the engine contain carbon monoxide gas which is poisonous and particularly dangerous since it is invisible and odourless.

Warming up the engine

Experience has shown that engines in vehicles used for frequent stopping and starting are subject to abnormally rapid wear. The reason for this is that the engine is not given a chance to reach its normal working temperature. When the engine is cold, it should just be taken up to its normal working temperature as quickly as possible. Therefore, do not idle the engine too long but start driving with a light load on the engine as soon as the oil pressure light has gone out.

Driving with the luggage compartment lid open

While driving with the luggage compartment lid partly or fully open, exhaust gases can be sucked into the car through the trunk. Normally, this involves no risk to passengers. However, the following advice should be followed on such occasions:

1. Keep all windows closed.
2. Set the fresh air and defroster controls to the fully-opened position and the fan switch to full speed.

OPERATING INSTRUCTIONS

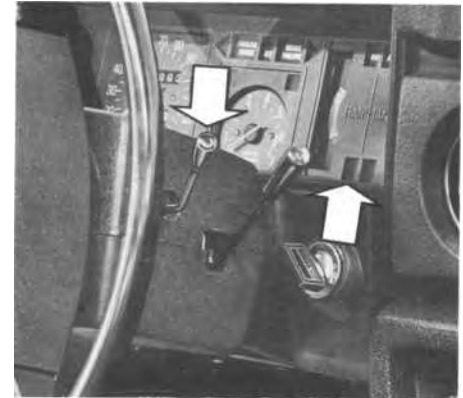
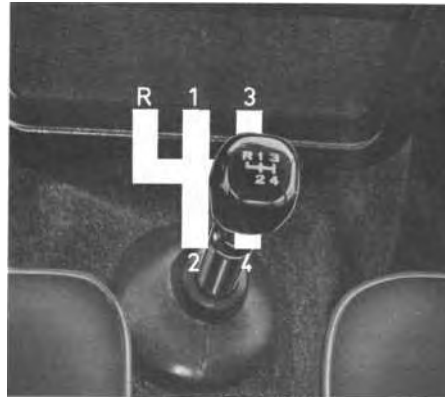

GEAR-CHANGING

The Volvo 164 is fitted with a gearbox with or without overdrive, or with an automatic transmission.

Note that certain versions are not sold on some markets.

The gearbox is synchronized on all forward gears. If synchronization is to function satisfactorily, the clutch pedal must be fully depressed.

Floor-mounted gear lever

Gear-changing with a floor-mounted gear lever is quite conventional and the different gear positions are shown in the picture above.

Overdrive

The overdrive, which can be engaged on fourth gear, is operated by means of a lever to the right under the steering wheel. Moving the lever downwards engages and upwards disengages the overdrive. No extra operation of the clutch pedal or accelerator is normally needed, but engagement is made easier if the accelerator pedal position is maintained steady. When disengaging the overdrive, light pressure on the clutch pedal helps to make this operation smoother.

The overdrive should not be used at speeds below 60 kmph (38 mph).

OPERATING INSTRUCTIONS



Automatic transmission

Gear selector positions

The gear selector positions are marked on the console next to the gear selector.

P = Parking
R = Reverse
N = Neutral
D = Driving
1 = Low gear
2 = Low gear

The gear selector can be moved freely between positions D and 2 while the other positions are provided with a gate which is "opened" by depressing the button in the knob of the gear selector.

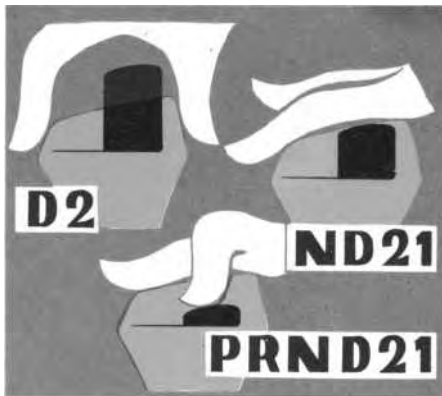

To change from D and 2 to positions N or 1 press lightly on the button with the palm of the hand. With the button thus lightly depressed, the selector lever can thus be moved between the four positions, 1, 2, D and N.

Changing to positions R and P requires more force on the button with, e.g., the thumb. This manipulation is also required to move the lever out of P position. In other words, when the button is pushed down fully, the selector lever can be moved freely between all the transmission positions.

P-position

The P position is selected for parking with or without the engine running. When parking on a hill, the parking brake should also be applied.

In P position, the gearbox is mechanically locked.

The P position may only be selected when the car is standing still.

R-position

The R position is used for reversing.

The R position may only be selected when the car is standing still.

N-position

The N position is the neutral position, that is, no gear is engaged.

D-position

Position D is the normal driving position. The car starts off here in first gear and automatically upchanges to second and third gear according to road speed and accelerator position. With decreasing vehicle speed, you get automatic downchange from third to second and first.

OPERATING INSTRUCTIONS

Position 2

In position 2 there is automatic up- and downchanging between first and second. But no upchanging to third.

Position 2 can be used to obtain immediate downchanging (to second) and when upchanging between second and third is not desired on, e.g., the following occasions

- with certain kinds of highway driving
- with slow town driving
- when driving in hilly country
- when overtaking
- in order to increase engine braking

Do not select position 2 for speeds above 125 kmph (78 mph).

Position 1

At position 1 downchanging takes place automatically but no upchanging.

If position 1 is selected at high speed, second gear engages. It is only when the speed has dropped to about 10 kmph (6 mph) that first engages. First can also be obtained by kick-down below about 50 kmph (30 mph).

Position 1 can be used when you want to engage first gear but do not want to change up. Such a situation would be, e.g., when driving in hilly country where maximum engine braking can be obtained in position 1.

Do not select position 1 for speeds above 125 kmph (78 mph).

Kick-down

When the accelerator pedal is depressed past full throttle position, kick-down is obtained, that is, there is an immediate shifting down to the next lower gear. As soon as a maximum speed for this gear has been reached or if the accelerator pedal is eased from the kick-down position, automatic shifting takes place to the next higher gear.

Remember

Do not select the P or R positions when the car is moving.

Do not select D, 2, 1 or R at engine speeds higher than idling when the car is standing still.

Do not select 2 or 1 at speeds above 125 kmph (78 mph).

Driving with automatic transmission

Move the selector lever to position P or N. A starter inhibitor prevents the engine from starting if the selector lever is moved to any of the other positions.

Starting off is as follows:

1. Check that the parking brake is on or depress the brake pedal (otherwise the car will start to move slowly when the selector lever is moved to any of the driving positions).
2. Move the selector lever to the intended driving position.
3. Release the parking brake and depress the accelerator pedal.

The car is stopped in the usual way by taking your foot off the accelerator pedal and depressing the brake pedal. No need to touch the selector lever.

If the car has to be extricated from snow, loose sand, etc., it can be "rocked" loose by moving the selector lever alternately between the D and R positions under continuous light accelerator pressure.

OPERATING INSTRUCTIONS

Towing with automatic transmission

If the battery is weak or run down and thus the selector lever in position N, providing the gearbox is correctly adjusted and the oil is at the right level. Maximum permissible speed when towing is 30 kmph (20 mph). The longest distance the car may be towed is 30 km (20 miles). If you have to tow your car longer than this distance or if you suspect a fault in the transmission, the rear wheels should be raised or the propeller shaft disconnected in order to avoid damage to the transmission.

Current regulations pertaining to max. speed when towing must be observed.

If your car has an automatic transmission, it cannot be started by towing.

If the battery is weak or rundown and thus cannot start the car, connect up an assist starter battery with its cables.

NOTE. Always wire the plus cable from the assist starter battery to the plus pole on the car battery and the minus cable to the minus pole.

MANUAL GEARBOX

Recommended max. and min. speeds, kmph (mph) for the different gears.

Engine	1st gear	2nd gear
B 30 E	0—55 (0—35)	20—90 (15—55)
B 30 F	0—55 (0—35)	20—90 (15—55)
	3rd gear	4th gear
B 30 E	35—140 (22—85)	45 (28)*—
B 30 F	35—140 (22—85)	45 (28)*—

* 60 kmph (38 mph) with overdrive engaged.

AUTOMATIC TRANSMISSION

Gear speeds at full throttle, kick-down, kmph (mph)

Gear	B 30 E	B 30 F
1—2	65 (40)	65 (40)
2—3	125 (78)	125 (78)

Max. speed when kick-down downshifting, kmph (mph)

Gear	B 30 E	B 30 F
3—2	110 (69)	110 (69)
3—1	50 (30)	50 (30)

OPERATING INSTRUCTIONS

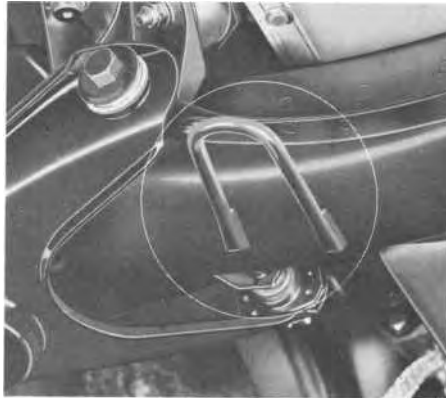

TOWING

Attach the tow line to one of the towing eyelets underneath the car. At the front, the towing eyelet is situated at the right-hand side (left picture) on the front axle member, and the rear eyelet to the right under the car (right picture). During towing, the tow line should be kept stretched to avoid unnecessary jerking. Concerning towing a car with automatic transmission, see page 26.

Note : Certain countries have regulations on max. speed when towing.



Starting by towing

The towing car should start smoothly and be driven at even speed in 2nd gear. Switch on the ignition.

Engage 3rd or 4th gear and gradually release the clutch pedal. Once the engine starts running, depress the clutch pedal.

Attention! A car with an automatic transmission cannot be started by towing, see recommendations on page 26.

IMPORTANT ABOUT BRAKING

When you drive your car in the rain or through pools of water, also when washing the car, water can splash on the brake discs and linings and thereby alter the friction properties of the brake linings so that a certain delay in braking effect can sometimes be noticed.

If you drive some distance in rain or slush, you should depress the brake pedal lightly now and again in order to heat up the brake linings and remove the moisture on them. This should also be done after washing the car and after starting in very damp weather.

When the brake servo is not functioning, e.g., on rolling the car with the engine switched off, pressure on the brake pedal must be 3 to 4 times greater if the same braking effect is to be achieved as when the servo is functioning. Note that the brake pedal travel will be short and stiff.

If one of the brake circuits should stop functioning (the red warning lamp F, see page 6 lights) twice the normal force on the brake pedal is required in order to achieve normal pedal pressure. Note that here the pedal travel will be long and the pedal will feel stiff and hard in the braking position. The car should be taken as soon as possible to a workshop for a check on the brake system.

TECHNICAL DESCRIPTION

Engine compartment

1. Radiator
2. Battery
3. Alternator
4. Charging regulator
5. Pressure sensor
6. Relay for fuel pump
7. Main relay for fuel injection
8. Air cleaner
9. Injector
10. Windscreen wiper motor
11. Pressure regulator
12. Oil filler cap
13. Oil dipstick
14. Ignition coil
15. Distributor
16. Starter motor
17. Brake power assist
18. Brake fluid container
19. Windscreen washer container
20. Steering gear, power steering
21. Relay for foglights
22. Main relay for ignition switch
23. Step relay for fullbeams and dipped headlights
24. Fusebox for foglights
25. Oil container for power steering
26. Expansion tank

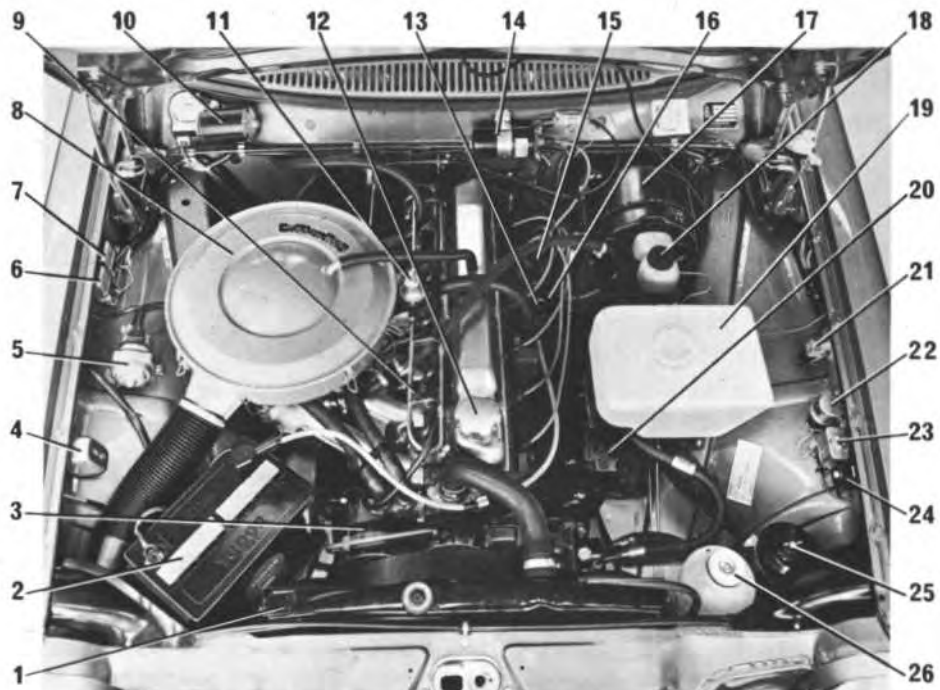

Note. Differences may occur for different markets.

TECHNICAL DESCRIPTION

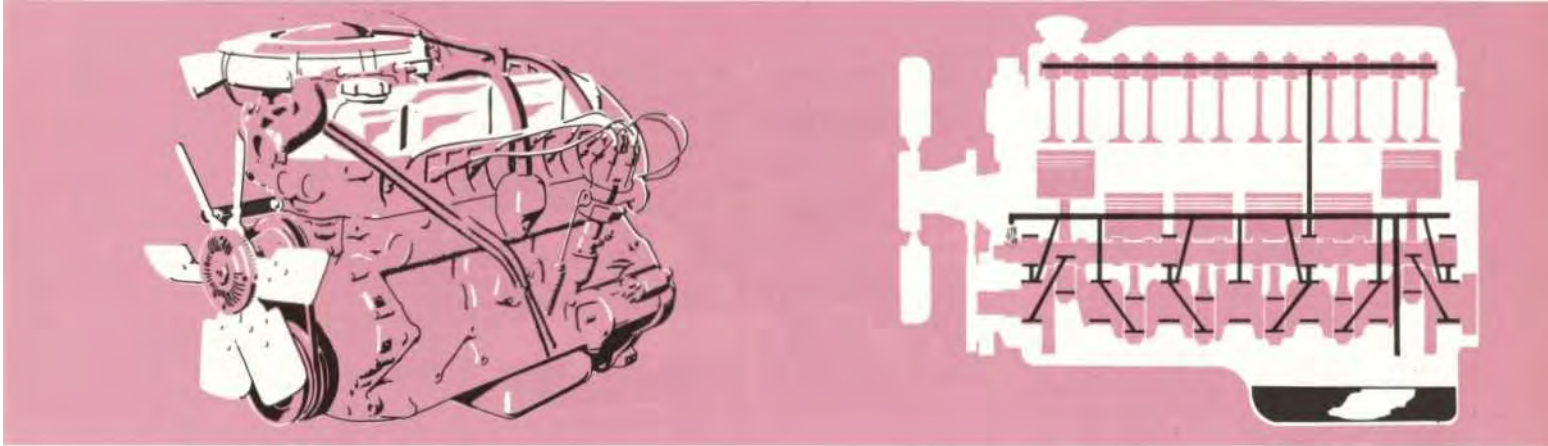

ENGINE

The engine is an in-line six-cylinder, water-cooled injection unit with overhead valves. The engine has a very rigid cylinder block made of special cast iron and is cast in one piece. The cylinder liners are machined directly in the block. The cylinder head has separate inlet and exhaust ports, one for each valve. The statically and dynamically balanced crankshaft is carried in seven main bearings.

Lubricating system

Engine lubrication is taken care of by a gear pump located in the oil sump. The pump is gear-driven from the camshaft. From the pump the oil is forced through the full-flow type oil filter and then along oilways to the various lubricating points. A relief valve is built into the oil pump and prevents the oil pressure from reaching excessively high values. The oil filter is of the fullflow type, that is, all the oil passes through the filter before continuing on to the engine lubricating points.

Cooling system

The cooling system is of the sealed pressure type and incorporates a circulation pump. When the engine is cold, the coolant circulates only inside the engine. As the engine warms up, a thermostat valve starts opening the outlet to the radiator. An expansion tank prevents air from circulating with the coolant as this would cause corrosion in the cooling system. The fan is driven via a slip coupling which keeps the fan speed at about max. 42 r/s (2 500 rpm).

TECHNICAL DESCRIPTION

Fuel system

This engine is fitted with an electronic fuel injection system.

This system includes an electronic control unit (7) that converts the impulses from the various sensors in the engine to control signals which regulate the six solenoid-actuated fuel injectors (15). The control signals influence the opening times of the injectors and thereby the amount of fuel injected.

The mixture of fuel and air is modified the whole time according to the conditions under which the engine is running. Engine speed is governed by the triggering contacts (13) in the distributor, the operating temperature by the sensor (17) for the coolant, the temperature of the induced air by the sensor (1) and the engine load by the pressure sensor (5) which is connected to the inlet duct. In addition, the control unit is provided with information concerning the position of the throttle valve by means of the throttle valve switch (2). This information is "computerized" in the control unit and re-transmitted in the form of control impulses to the injectors.

Fuel is injected into the inlet ports in the cylinder head just before the intake valves. The fuel is delivered to the injectors via an electric fuel pump (12) which maintains a constant pressure of 2.0 kp/cm² (30 psi) in the fuel line with the help of a pressure regulator (14).

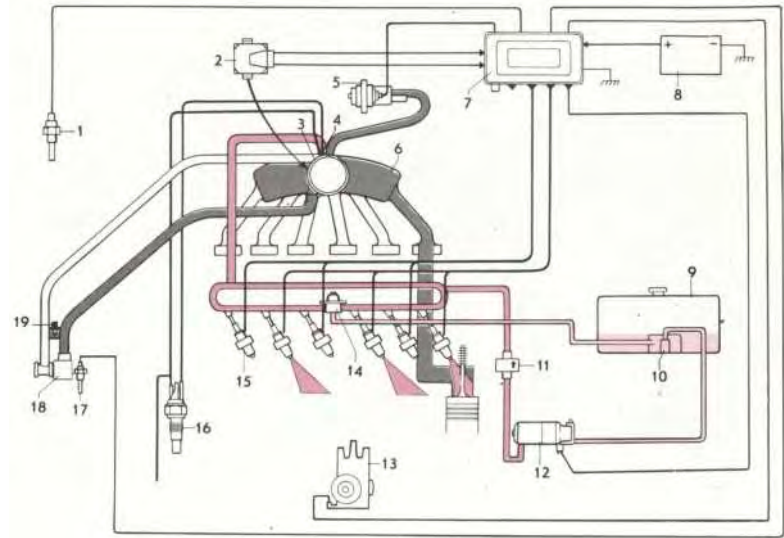

Principle of operation, fuel injection system

1. Temperature sensor for induction air
2. Throttle valve switch
3. Throttle housing
4. Cold start valve
5. Pressure sensor
6. Inlet duct
7. Control unit (electronic)
8. Battery
9. Fuel tank
10. Fuel filter, suction side
11. Fuel filter, discharge side

12. Fuel pump
13. Triggering contacts in distributor
14. Pressure regulator
15. Injectors
16. Thermal timer contact
17. Temperature sensor for coolant
18. Auxiliary air regulator
19. Idling adjusting screw

- Partial vacuum in inlet duct
- Fuel at atmospheric pressure
- Fuel below 2.0 kp/cm² (30 psi) overpressure

TECHNICAL DESCRIPTION

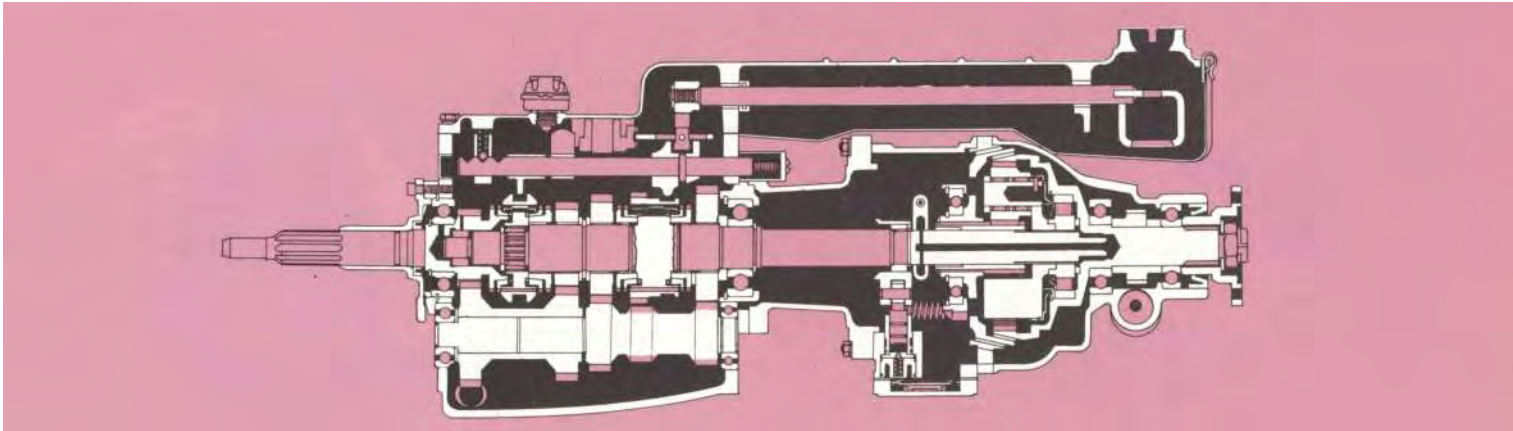

POWER TRANSMISSION

Clutch

The clutch is of the single dry plate type. Pressure on the pressure plate is obtained from a diaphragm spring which in turn is controlled mechanically by the clutch pedal via the throw-out yoke. (Hydraulic operation for vehicles with right-hand drive.)

Manual gearbox

The gearbox has synchromesh on all forward gears. Due to well-dimensioned synchronizing rings, gear-changing is fairly easy.

Overdrive

Certain variants of the Volvo 164 are fitted with an overdrive. With the overdrive, it is possible to reduce the engine speed while maintaining road speed. This is less wearing on the engine and reduces fuel consumption at the same time.

Automatic transmission

As an alternative, your Volvo can be fitted with a BW 35 automatic transmission.

In principle it consists of two main components - a hydraulic torque converter and a hydraulically operated epicyclic gearbox with a control system. The converter serves as a clutch and as an extra gear between engine and gearbox.

TECHNICAL DESCRIPTION

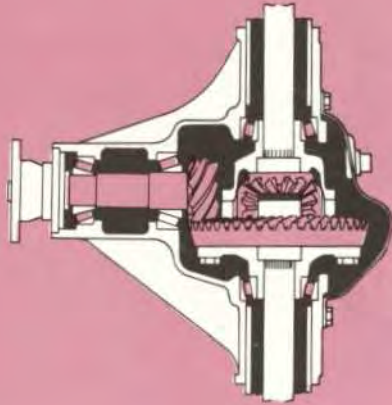

Propeller shaft

The propeller shaft, which is the connecting link between the gearbox and the rear axle, is divided into two sections. The forward section is flexibly mounted at its rear end in a rubberized ring.

Final drive

Engine torque is transmitted via the propeller shaft to the rear wheels through the final drive. The final drive is of the hypoid type, that is, the drive pinion lies below the centre line of the drive shafts.

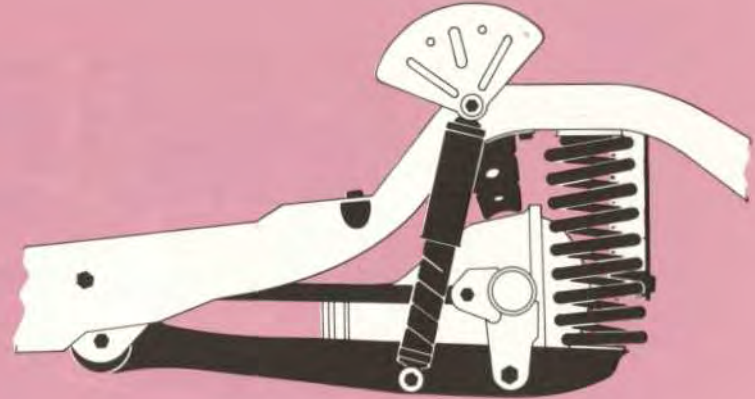

Limited slip differential

On certain markets, a limited slip differential can be obtained as optional equipment. A rear axle with a limited slip automatically transmits the tractive power to the wheel having the best road grip when a wheel begins to spin. Except for the differential unit, the rear axle is similar in design to a conventional rear axle.

Do not rotate a jacked-up rear wheel if the other rear wheel is still on the ground. Due to the differential unit, there is still drive on the wheel in contact with the ground. Rotating the jacked-up rear wheel would thus move the other rear wheel and may cause the car to topple off the jack.

Rear axle

The rear axle is carried on two support arms the front ends of which are bolted to the body. The rear axle casing is secured to the support arms by means of levers. Two torque rods are journalled on the casing and the body. A torque rod prevents lateral movement of the body and rear axle in relation to each other.

TECHNICAL DESCRIPTION

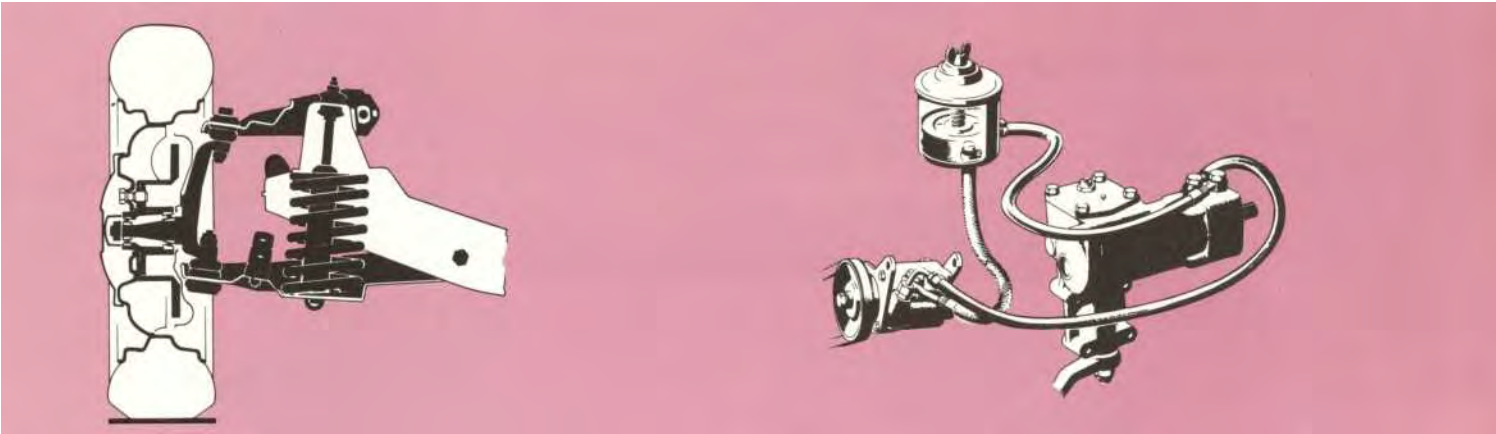

FRONT END AND STEERING

Front end

The front suspension units are mounted on a strong box member. The member is bolted firmly to the front section of the body. The front wheels are journalled in tapered roller bearings. The front springs consist of coil springs in which telescopic shock absorbers are fitted. The car is provided with stabilizers secured to the lower control arms and to the body.

Power steering

The power cylinder and steering valves are built into the cam-and-roller type steering gear. When the steering wheel is turned, the guide valves direct the pressure oil from the power pump to one of the sides of the piston in the power cylinder. The resultant pressure on the piston side affected assists in turning the steering wheel.

ELECTRICAL SYSTEM

The electrical system is of the 12-volt type and is fitted with a voltage-regulated alternator. The starter motor is operated by means of the ignition switch. This switch is also the main switch for the rest of the electrical system. The headlights, parking lights and interior lighting, however, are not wired via the ignition switch so they can be switched on and off without having to switch on the ignition key.

TECHNICAL DESCRIPTION

IMPORTANT!

Due to the fact that the integrity bulb sensor (control lamp for bulbs, see page 7) is dimensioned for a certain load, electric sockets for the rear and stop lights for caravans, trailers, etc. must not be connected up anywhere in the electrical system.

The cables for the electric socket for these functions, therefore, must be taken up to the dashboard where it is possible to connect them up.

Concerning replacement of bulbs and fuses, see pages 50-54.

Wiring diagram

1. Battery 12 V 60 Ah
2. Connection box
3. Ignition
4. Ignition coil
5. Distributor, firing order 1-5-3-6-2-4
6. Spark plug
7. Starter motor
8. Alternator
9. Charging regulator
10. Fusebox
11. Light switch
12. Bulb integrity sensor
13. Stop relay for mainbeam and dipped headlights, also mainbeam flasher
14. Mainbeam headlights
15. Dipped headlights
16. Parking light 5 W
17. Rear lights 5 W
18. Side-marking lights 3 W (only USA)
19. License plate lighting 2x5 W
20. Brake light contact
21. Brake light 32 cp
22. Contact on gearbox, M 400, M 410
23. Contact on gearbox BW 35
24. Reversing lights 32 cp
25. Emergency warning lights
26. Turn indicator lever switch
27. Switch, emergency warning flashers

28. Front flashers 32 cp
29. Rear flashers 32 cp
30. Connection at instrument
31. Connection at instrument
32. Warning lamp, brake failure 1.2 W
33. Connection at instrument
34. Rev counter
35. Temperature gauge
36. Fuel gauge
37. Voltage stabilizer
38. Control, turn indicator 1.2 W
39. Diode
40. Control lamp, mainbeams, 1.2 W
41. Bulb integrity sensor, 1.2 W
42. Warning lamp, battery charging, 1.2 W
43. Control lamp, parking brake, 1.2 W
44. Control lamp, choke, 1.2 W (only B 30 A)
45. Warning lamp, oil pressure, 1.2 W
46. Contact, passengers seat
47. Contact, driver's seat
48. Parking brake contact
49. Choke control contact (only B 30 A)
50. Temperature sender
51. Oil pressure contact
52. Brake warning contact
53. Start inhibitor relay (only on certain markets)
54. Fuel level sender
55. Horn
56. Horn pad
57. Lever windscreen wipers and washer
58. Windscreen wipers
59. Windscreen washer
60. Switch, fan
61. Fan
62. Switch, elec. heated rear window
63. Elec. heated rear window
64. Clock
65. Cigarette lighter
66. Rheostat, instrumental panel lighting
67. Instrumental panel lighting, 2 W
68. Lighting, control panel 1.2 W
69. Lighting, gear positions light, 1.2 W
70. Glove locker contact
71. Light, glove locker, 2 W
72. Roof light, 10 W
73. Door contact, left
74. Door contact, right
75. Relay, headlight wipers (only on certain markets)
76. Start inhibitor unit
78. Control lamp, seat belts, 1.2 W
79. Contact, seat belt, passenger seat
80. Contact, seat belt, driver's seat
81. Connector

82. Switch, overdrive, M 410
83. Contact for overdrive, M 410
84. Solenoid for overdrive, M 410
85. Control lamp, overdrive, 1.2 W
87. Headlight wipers (only on certain markets)
89. Heater element with thermostat, driver's seat, 30 W
90. Heater element, driver's seat 30 W
91. Warning buzzer, lights (only on certain markets)
93. Switch, compressor
94. Thermostat
95. Solenoid on compressor
96. Solenoid
97. Relay, fuel pump
98. Main relay, fuel injection
99. Starter valve
100. Thermal time switch
101. Control unit
102. Fuel pump
103. Throttle switch
104. Pressure sensor
105. Temperature sensor I
106. Temperature sensor II
107. Injectors
108. Cut-out contacts
109. Resistors
110. Lighting, engine compartment 18 W
112. Fusebox, foglights
113. Foglights, 55 W
114. Relay, foglights
115. Switch, foglights

Differences may occur for different markets.

The wiring diagram shows the foglights connected across the parking and dipped lights. On certain markets they are connected across the parking and mainbeam lights. On this occasion the white-red cable between the foglight relay (114) and the stop relay (13) is connected to 56 b. If the foglights are connected across only the parking lights, the cable goes to 56.

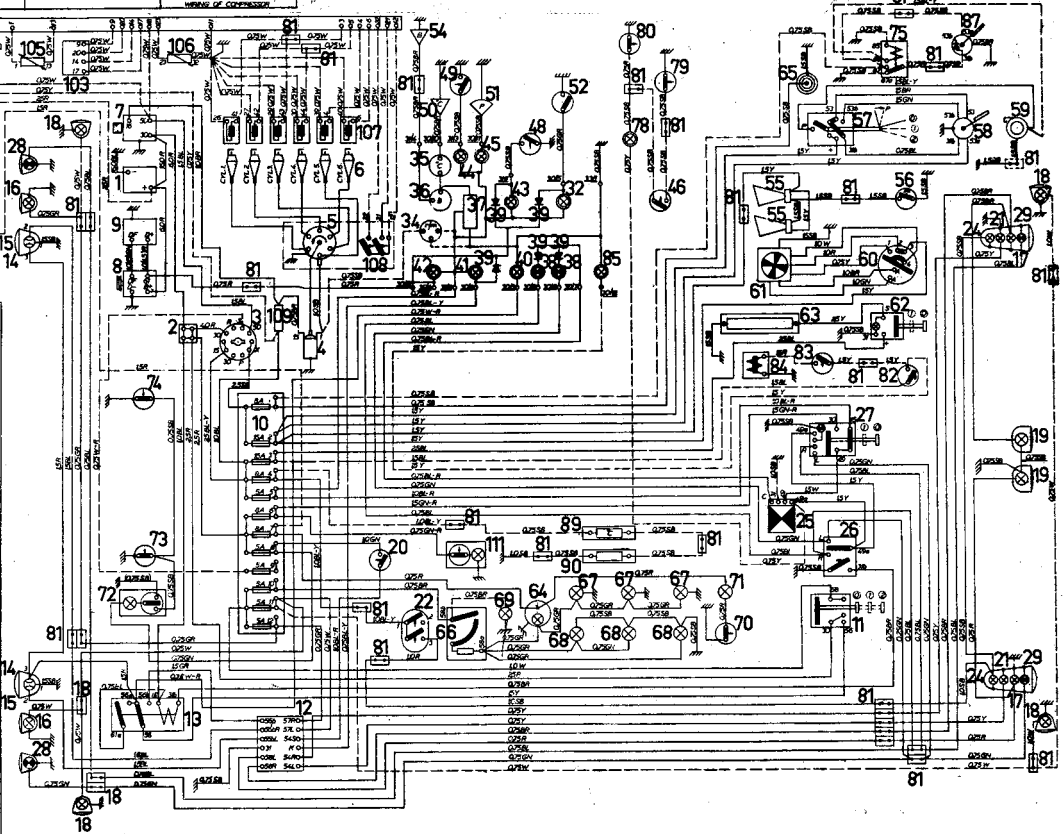
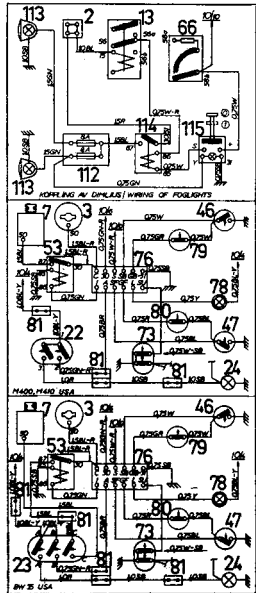
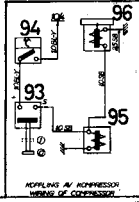
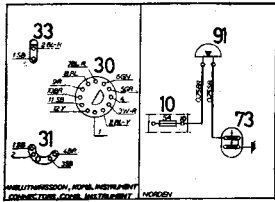

TECHNICAL DESCRIPTION

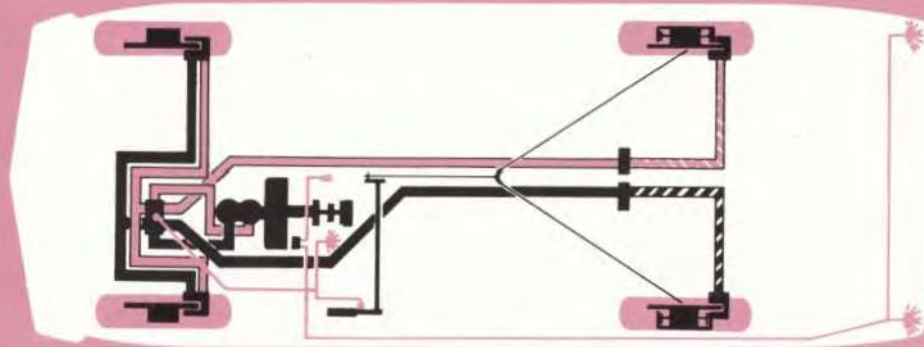

BRAKES

The brake system is of the two-circuit type with disc brakes all round. The system is provided with a tandem-type master cylinder and a directly-operating booster cylinder. When the brake pedal is depressed, the master cylinder operates mechanically via the booster cylinder, this increasing the pedal force about three times. The brake pressure is transmitted hydraulically from the master cylinder through the brake to the wheel cylinders. The pistons in these are then pressed outwards and apply the brake pads. The pressure lines to the rear

wheel brakes are provided with a reducer valve which prevents the rear wheels from locking before the front wheels. The principle of the two-circuit system is that both the front wheels are connected to one rear wheel, that is, should one of the circuits fail, there is always braking power on both front wheels and the other rear wheel. So at normal pedal pressure the braking effect of one of the circuits is 50 %, but when pedal pressure is increased, about 80 % of the full braking power can be obtained in the one circuit. This provides maximum safety

and prevents lateral dragging and rear-end lurching. With the engine stopped, the booster assists the braking a further two or three times after which the pedal pressure must be increased about three times as much in order to obtain a braking power corresponding to the braking power available with the engine running. The parking brake operates the rear wheels mechanically as the brake discs have also been designed as brake drums in order to incorporate the shoes for the parking brake.



GENERAL

Before the vehicle was delivered from the factory it was subjected to a very thorough inspection. Your dealer, in his turn, carried out a further delivery inspection in accordance with the specifications of the Volvo Factory.

In addition to this there is a service inspection after 2 500 km (1 500 miles) when the oil in the engine, transmission and rear axle is changed. Subsequent servicing of the vehicle should follow the routine in the service book which is based on service inspections every 10 000 km (6000 miles).

The simplest way to provide the vehicle with the servicing it requires is to have all the servicing done by a Volvo workshop.

The workshop stamp in the service book will show when vehicle was serviced.

When the car was being designed particular attention was given to the "safety details" (e.g. front end, brakes and steering). They are calculated to withstand the severest stresses with a wide safety margin. However, if you use your car for hard driving, you should take the precaution of checking these parts for fatigue cracks

during the useful lifetime of the car, for instance, when the parts concerned are being reconditioned.

If you prefer to carry out the simpler servicing procedures yourself or if you are sometimes obliged to have them done by a workshop outside the Volvo organization this chapter contains same advice as to when and how they should be carried out. For the sake of convenience, the servicing procedures have been summarized in a maintenance schedule in the next two pages.

SERVICING

MAINTENANCE SCHEME

In the maintenance scheme below the servicing procedures have been given certain numbers which refer to the detailed descriptions on the following pages.

Some of the work must be carried out by skilled mechanics or requires the use of special tools and these have been marked O.

Operation	Carried out every			Operation	Carried out every		
	10 000 km 6 000 miles	40 000 km 24 000 miles	See note below		10 000 km 6 000 miles	40 000 km 24 000 miles	See note below
LUBRICATION				ENGINE			
1. Lubricate body	●		● Once a year	13. Check oil level in power steering	●		
2. Check oil level in engine			● When filling the tank	14. Check brake fluid level (Also clutch fluid level, with r-h drive vehicle)			● When filling the tank
3. Change oil in engine	● ¹⁾		See page 41	15. Change brake fluid			○ Every third year
4. Check oil level in gearbox	●						
5. Change oil in gearbox		● ¹⁾		16. Servicing crankcase ventilation		●	
6. Check oil in overdrive	●			17. Replace oil filter	○		
7. Change oil in overdrive		○ ¹⁾		18. Clean filter in fuel tank			○ 20 000 km (12 000 miles)
8. Check oil level in automatic transmission	●			19. Change fuel filter			○ 80 000 km (48 000 miles)
9. Check oil level rear axle	●			20. Change air cleaner filter		●	
10. Change oil in rear axle			● ²⁾	21. Check valve clearances	○		
11. Check oil in rear axle with limited slip differential	●			22. Carry out compression test	○		
12. Change oil in rear axle with limited slip differential			● ²⁾	23. Check drive belts	○		
				24. Check coolant level			● When filling the tank

¹⁾ Also after the first 2500 km (1500 miles) during running-in.

²⁾ Only after the first 2500 km (1500 miles).

SERVICING

In addition to the servicing procedures mentioned in this scheme you should also check regularly the following from the point of view of traffic safety:

- a: turn indicators
- b: horn
- c: windscreen wipers and washer
- d: rearview mirrors

Operation	Carried out every		See note below
	10 000 km 6 000 miles	40 000 km 24 000 miles	
25. Change coolant			● Every other year
26. Check spark plugs	○		
27. Check ignition contact breakers	○		
28. Check ignition timing setting	○		
ELECTRICAL SYSTEM			
29. Check electrolyte level in battery			● When filling the tank
30. Check state of charge of battery	○		
31. Check headlight alignment	○		
POWER TRANSMISSION			
32. Check release arm travel	○		○ Once a year
33. Check propeller shaft	○		

Operation	Carried out every		See note below
	10 000 km 6 000 miles	40 000 km 24 000 miles	
BRAKES			
34. Check brakes	○		○ Every 3 years
35. Replace booster cylinder air filter and overhaul brakes			
FRONT END			
36. Check front wheel alignment	○		○ Once a year
37. Check ball joints, steering rods etc.	○		○ Once a year
WHEELS AND TYRES			
38. Check tyre pressure			● When filling the tank
BODY			
39. Washing			See page 57
40. Polishing			See page 58
41. Cleaning			See page 58
42. Rustproofing treatment			See page 58

SERVICING

LUBRICATION

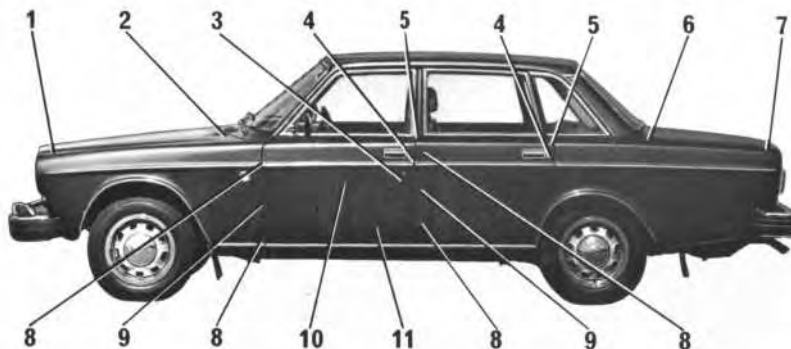

Chassis maintenance

To simplify maintenance of your Volvo, the vehicle has been equipped with ball joints, steering rods and propeller shafts of such a construction that they do not require regular lubrication. This has been possible due to the fact that points normally requiring lubrication have been packed with very durable grease at the factory and then carefully sealed, this obviating the need for subsequent lubrication.

But, to ensure that these parts are functioning properly, seals and rubber sleeves should be well-checked every 10000 km (6000 miles), suitably during the 10 000 km (6000 miles) inspection.

Oil should be changed or the oil level checked after every 10 000 km (6000 miles) in accordance with the lubricating chart at the end of the book. The measures taken in this inspection are also to be found in the lubricating chart.

Always use only first-class lubricants of a well-known make. The right lubricants in the right quantity at the right time will increase both the lifetime and the reliability of your car.

1 Body lubrication

In order to avoid rattle and unnecessary wear, the body should be lubricated once a year. The hinges on the bonnet, doors and luggage compartment lid as well as door stops should be lubricated every 10 000 km (6000 miles*). Moreover, during the winter months the locks on the doors and luggage compartment lid should be given some anti-freeze to prevent them from freezing up.

* Included in the 10 000 km (6000 miles) inspection.

No Lubricating point

1. Bonnet latch
2. Bonnet hinges*
3. Key hole
4. Striker plate
5. Door lock outer slide surfaces
6. Trunk lid hinges*
7. Trunk lid lock
Key hole
8. Door hinges*
9. Door stop*
10. Window regulator
Lock mechanism
(Accessible after door
upholstery panels removed)
11. Front seat slide rails and
latch devices

Lubricant

- Paraffin wax
- Oil
- Lock oil
- Paraffin wax
- Paraffin wax
- Oil
- Oil
- Lock oil
- Grease
- Paraffin wax
- Oil and grease
- Silicon grease
- *
- Paraffin wax
and oil

SERVICING



2 Checking the oil level in the engine

The oil level in the engine should be checked each time the fuel tank is filled. The check should be carried out with the engine switched off but warm and, in order to obtain comparable values, about one minute after the engine has been stopped. Wipe the dipstick before measuring. The oil level should be between the two marks on the dipstick. It must never be permitted to go down below the lower mark, but on the other hand, it should not be above the upper mark since oil consumption will then be abnormally high. If necessary, top up by filling through the oil filler hole in the rocker arm casing with new oil of the same type already in the engine.

The gap between the marks on the dipstick corresponds to approx. 2 dm³ (litres) (2 qts) oil.

3 Changing the engine oil

With a new or reconditioned engine, the oil should be changed after the first 2500 km (1500 miles). Subsequent oil changing is according to the intervals given below. For engine lubrication, oil grade "For Service SE", is to be used (previous designation MS).

Concerning viscosities, we recommend primarily multigrade oils due to the fact that these span a large viscosity range and make it unnecessary to change oil because of variations in ambient temperature.

Change the oil in the engine every 10 000 km (6000 miles). For cars used in taxi service and in large towns, however, the oil should be changed every 5000 km (3000 miles). No matter the type of driving, the oil should be changed at least twice a year. At very low temperatures below -20 °C (= -40 °F) multigrade oil SAE 5 W-20 is recommended. However, this oil should not be used when the temperature is continuously above 0 °C (32 °F).

The old oil is drained off by removing the drain plug in the sump. Draining should take place after driving when the oil is still warm.

Viscosity Oil grade	Temperature range	Oil change intervals km (miles)*	Oil capacities
SAE 10 W-30 } SAE 10 W-40 } SAE 20 W-50 "For Service SE"	all year round for all temp. above -10°C (14°F)	10 000 (6000) (or at least twice a year)	No oil filter 5.2 dm ³ (litres) 9.2 Imp. pints
SAE 10 W SAE 20/20 W SAE 30 "For Service SE"	below -10°C (14°F) between -10°C and +30°C (14 and 80°F) above 30°C (80°F)	taxi traffic or similar: 5000 (3000)	With oil filter 6.0 dm ³ (litres) 10.6 Imp. pints

*) During running-in change the oil after the first 2500 km (1500 miles).

SERVICING

4-5 Gearbox M 400

The oil in the gearbox should be checked after every 10 000 km (6000 miles). The oil level should be up to the filler hole. If necessary top up with the recommended oil. After every 40 000 km (24 000 miles) the oil in the gearbox should be changed. In the case of a new or reconditioned gearbox the oil should also be changed after the first 2500 km (1500 miles) and the gearbox thoroughly flushed with the same type of oil subsequently used. The old oil should be drained off immediately after the vehicle has been run while the oil is still warm.

Oil grade	Viscosity	Oil capacity
Gear oil alt.	SAE 90 At temperatures below -10°C (14°F) SAE 80	0.6 dm ³ (litre) 1.1 Imp. pints
Engine oil	SAE 30	

6-7 Gearbox with overdrive M 410

For cars fitted with an overdrive, the oil level should be checked and the oil changed parallel with similar procedure for the gearbox. The overdrive and the gearbox have a common oil level and oil filler hole. Make sure when topping-up that the oil runs over into the overdrive. The oil is drained out by removing the gearbox drain plug and the cap for the overdrive oil strainer. At each oil change the oil filter of the overdrive should be cleaned. This should be done by a Volvo workshop.

Oil grade	Viscosity	Oil capacity
Engine oil	SAE 30 or Multigrade SAE 20 W-40	1.4 dm ³ (litres) 2.5 Imp. pints

8 Automatic transmission BW 35

The oil in the automatic transmission should normally not be changed but the oil level should be checked every 10 000 km (6000 miles). The filler pipe with graduated dipstick is to be found under the bonnet just in front of the cowl.

NOTE. The dipstick has different graduation marks for a warm and cold transmission. When the oil level is being checked, the car should be standing level. With the engine idling in position P, the level should be between the upper and lower graduation marks on the dipstick. When topping-up is necessary, use only Automatic Transmission Fluid, Type F.

If this oil is not available, Type A or Dexron may be used.

The dipstick should be wiped with a nylon cloth, paper, etc. Cloths which leave fluff on the dipstick must be avoided.

For cars used for hard driving, or in hilly countries, etc., preventive service should be carried out by an authorized Volvo workshop every 40 000 km (24000 miles).

Oil grade	Oil capacity
Automatic Transmission Fluid, Type F (If unavailable, Type A or Dexron)	8.2 dm ³ (litres) 14.4 Imp. pints

SERVICING

9-10 Rear axle

The oil level in the rear axle should be checked after every 10 000 km (6000 miles). The oil level should be up to the filler hole. If necessary top up with the recommended oil. The oil in the rear axle should be changed after the first 2500 km (1500 miles). The old oil is drained off by removing the bottom plug. After this only the oil level need be checked and topping-up with recommended oil carried out if required.

The oil should then be warm and the magnetic plug must be well cleaned. It is of great importance to the lifetime of the final drive that particles and impurities from running-in are removed.

11-12 Limited slip

Cars fitted with a limited slip differential are delivered from the factory with a rear axle oil according to the American Military Standard MIL-L-2105 B provided with an additive for rear axles with limited slip. A similar type of oil should be used for subsequent topping-up and changing. Oil level checking and oil changing should be carried out at the same intervals and in the same way as for a rear axle without limited slip.

13 Power steering

The oil level in the power steering should be checked every 10 000 km (6000 miles). Before checking wipe the oil container clean. Then remove the cap and check the level with the engine stopped. The oil level should be about $\frac{1}{4}$ " (5-10 mm) above the level mark in the container. If the level is lower than this, top up with the engine stopped to prevent air from being sucked into the container. Start the engine and re-check the oil level, which should now fall to the level mark. When the engine stops, re-check the oil level, which should be about 5-10 mm ($\frac{1}{4}$ ") above the mark. The oil and filter in the power steering do not need replacing other than during repairs or reconditioning.

Oil grade	Viscosity	Oil capacity
Rear axle oil acc. to MIL-L-2105 B	SAE 90 At temperatures continuously below -10°C ($+14^{\circ}\text{F}$), SAE 80	1.6 dm ³ (litres) 2.8 Imp.pints

Rear axle oil MIL-L-2105 B must be provided with additive for limited slip differential.

Oil grade	Oil capacity
ATF Type A or Dexron	1.2 dm ³ (litres) 1.9 Imp. pints

SERVICING

14-15 Brake fluid

The brake system is fitted with a tandem-type brake fluid container with a section for each circuit but with the same filler hole. The brake fluid level should be between the "Max" and "Min" marks. (For right-hand drive, check also clutch fluid level.)

Every third year or every 80 000 km (48000 miles) change the brake fluid in the entire brake system. The brake system seals should be replaced at the same time.

A suitable time to do this is when changing the power cylinder air filter, see page 54. With continuous driving where the brakes are used often and hard, for example, when hill-climbing, etc. and in extremely damp weather, the brake fluid should be changed once a year.

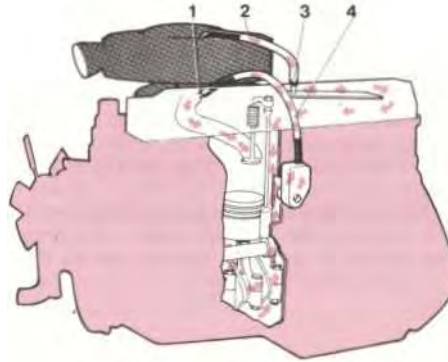

17 Oil filter

ENGINE

16 Crankcase ventilation

The engine is provided with positive crankcase ventilation which prevents the gases in the crankcase from being released into the atmosphere. Instead, they are sucked into the intake manifold and take part in the combustion process whereupon they are blown out through the exhaust pipe together with the other combustion gases. Every 40 000 km (24 000 miles) remove and clean the nozzle (1), the houses (2 and 4). Rubber hoses should also be replaced if they are in a poor condition. Replace the flame guard (3).

The engine is fitted with a full-flow type oil filter, which means that all the oil passes through the filter on its way from the oil pump to the various lubricating points. Impurities in the oil are collected in the filter and gradually block it. For this reason, the filter must be changed every 10000 km (6000 miles). Scrap the old filter then. If the oil filter is replaced without the engine oil being changed, the engine should be topped up with 0.8 dm³ (litre) (1 pint) of oil.

Brake fluids meeting the requirements according to SAE J 1703 should be used for the hydraulic brake system. Brake fluid with designation SAE 70 R 3 can also be used.

SERVICING



18 Cleaning filter in fuel tank

A filter is fitted in the suction line in the fuel tank. Its function is to prevent any dirt in the tank from being sucked up to the fuel pump.

The filter should be cleaned every 20 000 km (12000 miles). Before submitting your car for cleaning of this filter, try to drive the tank empty.

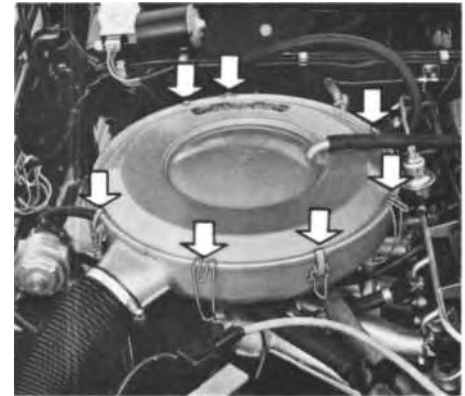

20 Air cleaner

The air cleaner consists of a container with a replaceable paper insert. The insert should be replaced after every 40 000 km (24 000 miles). When driving regularly in dusty areas, the insert should be replaced more often. No other servicing is required between the above intervals.

To replace the insert, undo all the clasps securing the cleaner cover, take off the cover and the insert is accessible for replacement.

When re-fitting the cover on the cleaner make sure that the arrow points on the cover and the lower section of the air cleaner coincide with one another.

19 Fuel filter

The fuel filter is located under the car close to the fuel tank. This filter is to be changed after every 80 000 km (48 000 miles). The filter is replaced as one complete unit.

Filter replacement should be carried out in a Volvo workshop.

SERVICING

21 Valves

The valve clearance should be checked after every 10 000 km (6000 miles). The check should be carried out in a workshop.

22 Compression test

To get some idea of the condition of the engine, a compression test should be carried out after every 10 000 km (6000 miles). This test should preferably be carried out in a workshop.



23 Drive belts

The belt tension can be checked by pressing in the fan belt at a point midway between the alternator and the fan. It should be possible to press down the belt there about 10 mm (3/8 ") with normal pressure (7.5-11 kp = 16-24 lb). If the car has air conditioning, carry out the same check on the compressor drive belt, but with a pressure of 9-12 kp (20-26 lb). The check can suitably be carried out in a Volvo workshop. Also check the tension on the drive belt for the power pump. It should be possible to depress the belt midway about 5 mm (3/16")

24 Checking the coolant level

The cooling system must be well filled with coolant and not leak if it is to operate at maximum efficiency. Check the coolant level when filling up with fuel. The level should be between the "Max" and "Min" marks on the expansion tank. The check should be carried out with particular thoroughness when the engine is new or the cooling system has been empty.

Do not remove the filler cap other than for topping-up with coolant. Frequent removal may prevent coolant circulation between the engine and the expansion tank during engine warming up and cooling.

Topping-up with coolant

Top-up with coolant by filling the expansion tank when its level has gone down to the "Min" mark. Use all the year round a mixture of 50% reliable anti-freeze and 50% water. Top up to the "Max" mark.

NOTE. Do not top up with water only, particularly during the wintertime. Water by itself reduces both the rust-protective and anti-freeze qualities of the coolant. It can also cause damage to the cooling system if ice should form in the expansion tank.

NOTE. In very warm parts of the country where there is little risk of frost, water can be used without anti-freeze.

SERVICING



25 Changing the coolant

The coolant retains its properties for approx. 2 years when it should be changed. A suitable time to do this would be in the autumn to preclude any damage by frost during the coming winter. To drain the cooling system, unscrew the drain plug located on the right hand side of the engine and disconnect the hose connected to the bottom of the radiator. The expansion tank is emptied by removing it from its brackets and lifting it to a sufficient height so that the coolant can flow into the radiator. Before filling with new coolant, flush the entire system with clean water.

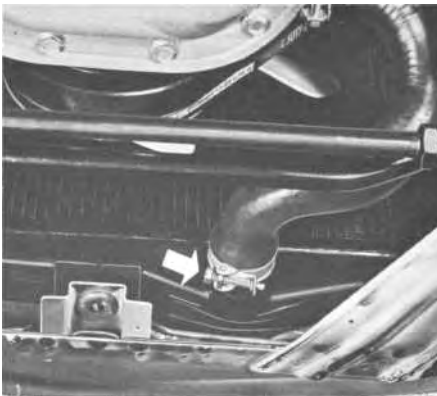

26 Checking the spark plugs

The spark plugs should be removed and checked every 10000 km (6000 miles). Adjust the electrode gap to 0.7-0.8 mm (0.028-0.032").

Tightening should preferably be done with a torque wrench. The spark plugs should be tightened to a torque of 34-39 Nm (25-29 lbft). When fitting new plugs, be sure to fit the right type.

B 30 E Bosch W 225 T 35 or corresponding.
B 30 F Bosch W 200 T 35 or corresponding.

27 28 Ignition system

The distributor contact breaker gap and the engine ignition timing should be checked every 10 000 km (6000 miles).

All adjusting work should be done by a workshop with the proper equipment. The distributor is one of the most sensitive units in the engine and careless handling can lead to decreased engine output and high fuel consumption or even serious damage to the engine.

The cooling system is filled with coolant through the filler opening on top of the radiator. When this is being done, the heater control should be set to max. heat to ensure that the entire system is filled. Fill the radiator to the top and fit on the cap. Then fill the expansion tank to the "Max" level or slightly above this.

Run the engine warm, switch off the ignition and allow the engine to cool. Check that the radiator is full and that the coolant in the expansion tank is at "Max". If necessary, top up the system.

SERVICING

Fuel

For the B 30 E engine: minimum 97 octane (RON)*.

For the B 30 F engine: minimum 91 octane (RON)*.

Running on too low an octane will give rise to knocking, etc. On certain markets where it is difficult to procure petrol with these octanes, the engine can be adapted accordingly to suit other octanes.

*RON = Research Number

Special instructions when working on the electronic fuel injection system

1. **Never** let the engine run without the battery being connected.
2. **Never** use a high speed battery charger as a starting aid.
3. When using a high speed charger to charge the battery in the vehicle, the battery should be disconnected from the rest of the electrical system.
4. The control unit **must not** overheat above $+85^{\circ}\text{C}$ (185°F). The control unit must not be connected up (the engine started) when the ambient temperature exceeds $+70^{\circ}\text{C}$ (158°F). (With paintwork, etc., when the vehicle is being oven-heated, it may not be driven out of the oven, it must be conveyed out. If there is risk of temperatures exceeding $+85^{\circ}\text{C}$ (185°F), the control unit must first be removed.)
5. The ignition should be switched off before connecting up or disconnecting the control unit.
6. For all work with fuel lines, **great** care must be taken to ensure that no dirt enters the system. Even tiny dust particles can jam injectors.

Any work to be done on the electronic fuel injection system should be carried out by an authorized Volvo workshop which has the proper equipment for doing this.

ELECTRICAL SYSTEM

29 Checking the battery electrolyte level

The electrolyte level should be checked regularly. A suitable time to do this is when the fuel tank is being filled. The electrolyte level should be 5-10 mm (3/16--3/8") above the top of the cell plates. If the level is too low, top up with distilled water. Never check the electrolyte level with a lighted match. The gases formed in the cells are highly explosive.

30 Checking the state of charge of the battery

The state of charge of the battery should be checked after every 10 000 km (6000 miles). The check is made with the help of an hydrometer which shows the specific gravity of the battery acid. See page 66. At the same time, check the lead terminals and terminal studs to make sure that they are tight, coated with grease and that the battery is firmly fixed.

31 Checking headlight alignment

The alignment of the headlights should be checked in a workshop after every 10 000 km (6000 miles).

NOTE that the headlight beams can alter their angle on the road according to the load in the car.

This car is fitted with an alternator.

When changing the battery or when carrying out work involving the electrical system, the following should be observed.

1. A battery connection to the wrong terminal will damage the rectifiers. Before connections are made, check the polarity of the battery with a voltmeter.
2. If assist batteries are used for starting, they must be properly connected to prevent the rectifiers from being damaged.
The negative lead from the assist battery for starting must be connected to the negative terminal stud of the car battery and the positive lead from the assist battery for starting to the positive terminal stud.
3. If a rapid charger is used for charging the battery, the car battery leads should be disconnected.
A rapid charger may not be used as an aid in starting.
4. Never disconnect the battery circuit (for example, to change the battery) while the engine is running, as this will immediately ruin the alternator. Always make sure that all the battery connections are properly tightened.
5. If any electrical welding work is to be carried out on the vehicle, the ground lead and all the connecting cables of the alternator must be placed as near the welding point as possible.

SERVICING



Replacement of bulbs

The replacement of bulbs in the various lighting units is shown on the following pages. Make sure when fitting bulbs that the guide pin on the bulb fits into its corresponding socket.

When fitting bulbs, do not touch the globe with your fingers. The reason for this is that grease, oil or any other impurities can carbonize on the bulb and damage the reflector.

Replacing the bulbs for the front turn indicator flashers and parking lights

Remove the two Phillips screws which hold the glass. The bulbs can now be removed by pressing them inwards and then turning them a little anti-clockwise. The inner bulb (1) is for the parking light, the outer (2) for the turn indicator.

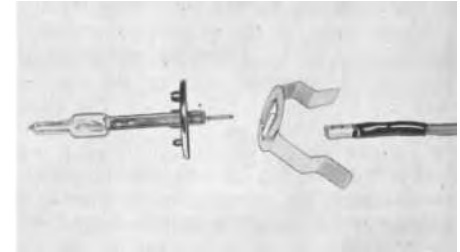

Replacing the foglight bulbs

The bulbs for the foglights are replaced from inside the engine compartment. Remove the protection covering the space over the headlight and foglight. Squeeze the spring holding the bulb and lift out the spring and bulb. The bulb is now accessible for replacement. Because of the two bosses on the bulb holder, the bulb can only be fitted in one way.

Replacing the headlight bulbs

The headlight bulbs are replaced from inside the engine compartment:

1. Remove the protective cover over the space behind the respective headlight.
2. Remove the bulb holder contact.
3. Remove the rubber cover.
4. Remove the spring holding the bulb holder in its correct position. Lift out the bulb. When installing the new bulb, make sure that the three guide pins enter their respective sockets in the holder. Do not touch the bulb globe with the fingers.

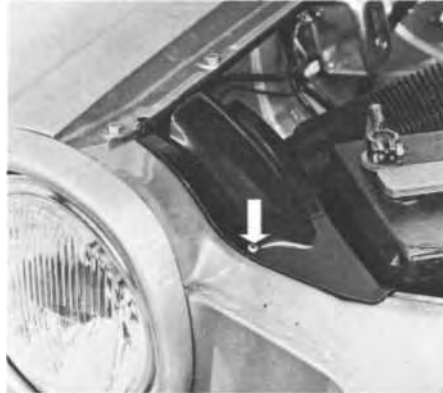

1



2

Replacing bulb for light in engine compartment

Slacken the screw securing the bulb holder. The bulb is then accessible for replacement.



3

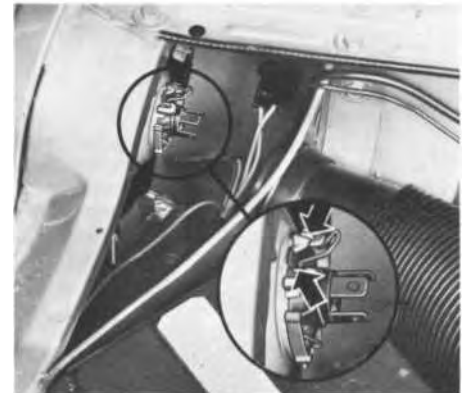

4

SERVICING

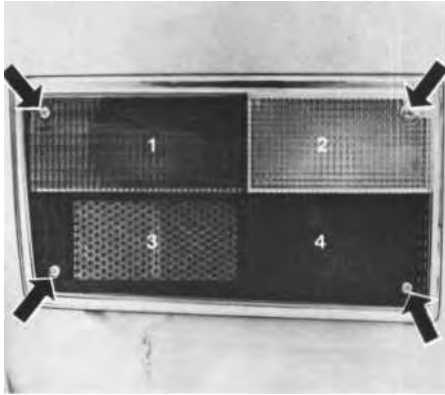

Replacing the bulbs for the rear turn indicators, parking lights, stop lights and reversing lights

Remove the four Phillips screws which hold the glass. The bulbs can now be removed by pressing them inwards and turning them slightly anti-clockwise at the same time. They are as follows:

1. Turn indicator
2. Reversing light
3. Rear light
4. Stop light

Make sure that the sealing strip fits well against the glass when it is re-fitted.

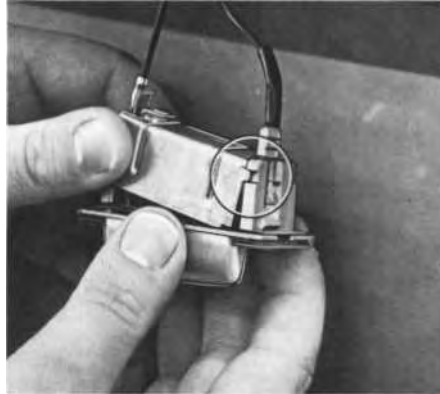

Replacing the bulbs for the license plate lighting

The license plate lighting is provided with two bulbs. Should any of them require replacing, proceed as follows:

1. Press in the tab catch in the bulb housing by inserting a screwdriver in the opening on the left-hand side of the housing. Pull the bulb housing out of its attachment.
2. Pull out the casing end not provided with a guide pin.
3. The bulb is now accessible for replacing.

When fitting the unit, first insert the guide pins in the sockets (see picture) and then press on the casing. Check that the rubber strip fits properly in position and press the lamp housing securely into position.

Replace bulbs for instrument lighting, switches and heater control lighting

Owing to the location of the bulbs, their replacement should be carried out by a Volvo workshop.

Replace bulb for glove locker

Pull the bulb plastic cover straight down. The bulb is then accessible for replacement.



Replacing roof light bulb

To replace this bulb, remove the glass by pushing in the catch with a screwdriver which is inserted in the opening in the right-hand side of the light. Then pull the glass cover off its attachment. The bulb is now accessible for replacement.

Fuses

The fuses are grouped under a cover at the bottom of the dashboard extreme left. Reading downwards the fuses protect the following:

- | | | |
|-----|---|------|
| 1. | Cigarette lighter | 8 A |
| 2. | Windscreen wiper, washer
Horn
Heater fan | 16 A |
| 3. | Elec. heated rear window
Overdrive | 16 A |
| 4. | Heater element, driver's seat
Reversing lights | 8 A |
| 5. | Turn indicators
Instrumentation, Warning lamps | 5 A |
| 6. | Emergency warning flashers
Engine compartment lighting | 8 A |
| 7. | Fuel pump
Clock
Glove locker lighting | 8 A |
| 8. | Brake lights
Interior lighting | 5 A |
| 9. | Spare | 5 A |
| 10. | Instrument panel lighting | 5 A |
| 11. | Rear light, left
Parking light, left
License plate light, left | |
| 12. | Rear light, right
Parking light, right
License plate light, right | 5 A |

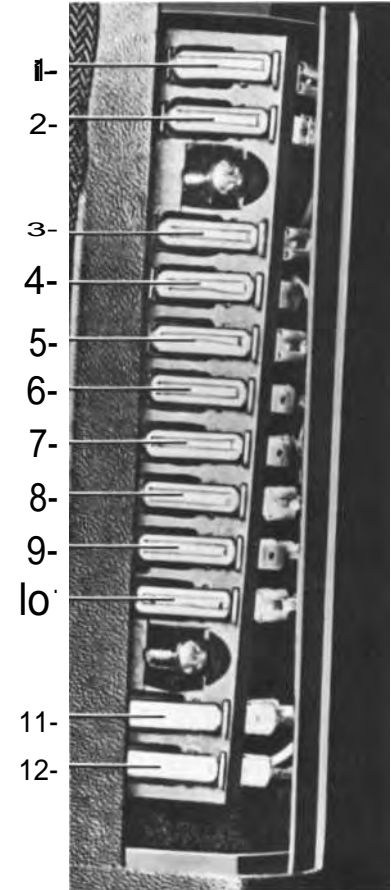

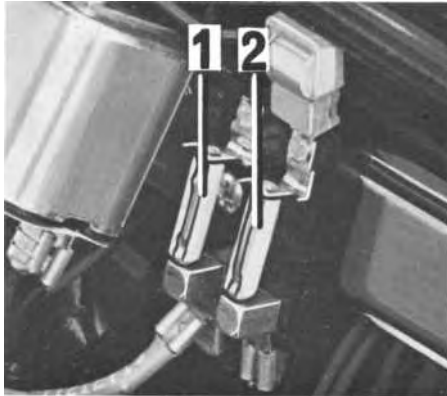

There is also an extra fusebox located in the engine compartment on the left-hand wheel arch.

The fuses here protect:

1. Foglight, left
2. Foglight, right

8 A
8 A

POWER TRANSMISSION

32 Checking the clutch yoke play

To avoid risk of the clutch slipping, the clutch yoke travel should be checked and adjusted if necessary every 10 000 km (6000 miles).

33 Checking the propeller shaft

After every 10 000 km (6000 miles) or once a year the rubber seal on the spline shaft and the universal joints should be checked. If the rubber seal is damaged, it should be replaced and the new seal filled with molybdenum disulphide grease.

BRAKES

34 Checking the brakes

After every 10 000 km (6000 miles) the vehicle should be taken to a Volvo workshop for a check on the function of the brakes.

35 Replacing the booster cylinder air filter and overhauling the brakes

Every third year or 80 000 km (48 000 miles) the car should be taken to a Volvo workshop for replacement of the booster cylinder air filter.

See also under "Brake fluid", page 44.

FRONT END

36 Checking the front wheel alignment

Correct front wheel alignment is of vital importance for the steering of the vehicle. Faulty adjustment can mean heavy wear on the tyres. For this reason, have the front wheel alignment checked regularly at your local Volvo workshop every 10 000 km (6000 miles). If the vehicle has been in collision involving heavy impact and it is suspected that the wheel alignment may have been affected, take the vehicle to a Volvo workshop for a check on the front wheel alignment as soon as possible. Volvo workshops have special measuring equipment for this purpose and can carry out this control very quickly. The front wheel alignment angles are shown on page 67.

37 Checking the ball joints, steering rods, etc.

After every 10 000 km (6000 miles) the vehicle should be taken to a workshop for a check on the front end concerning excessive play in the ball joints, steering gear, etc. After every 10 000 km (6000 miles) or at least once a year, the ball joint seal should also be checked for damage and leakage. When new seals are fitted they should be filled with the recommended grease.

WHEELS AND TYRES

General

The car is fitted with pressed steel wheels with wheel cap, which is screwed to the hub cap. Wheel rims are of size 5 1/2 J 15" F.H. All wheels are accurately balanced. The tyres are 175 HR 15 tubeless.

The maximum permissible speed for 175 HR 15 tyres is 210 kmph (130 mph).

Radial tyres should always be used when replacing and when changing over from summer to winter tyres.

Throughout its lifetime, the car tyre should if possible have the same direction of rotation. In other words, it should be kept on the same side of the car all the while in use. This is of particular importance for studded snow tyres, since a change in direction of rotation can cause the studs to loosen.

Studded snow tyres should also have a running-in period of between 500-1000 km (300-600 miles). During this period avoid hard driving in bends and high speeds, also hefty braking and hasty acceleration.

Rapid links must not be fitted on the Volvo 164 since the space between the brake calipers and wheel rims do not permit this.

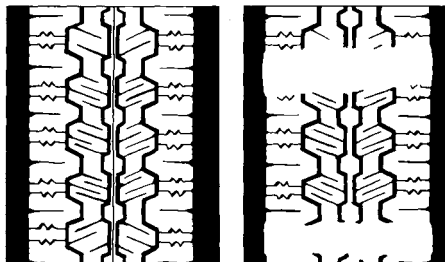

Check the tyres at regular intervals for damage and abnormal wear, also for stones which can fasten in the tread. Have them balanced if necessary. Poorly balanced wheels will rapidly increase the wear on tyres as well as make for poor travelling comfort.

The tyres have a so-called "wear indicator" in the form of a number of specially patterned sections in the tread. When about 1.5 mm (1/16") is left on the tread in these sections, these sections show up and warn the car owner in good time that the tyre is showing signs of wear.

38 Checking the tyre pressure

Make a habit of checking the pressure in the tyres regularly. The simplest way to do this is to check the pressure at a service station while filling up with fuel. See ' page 67 for the correct air pressure.

Do not forget the spare wheel when checking the air pressure.

During driving, the temperature of the tyres rises and also the air pressure in relation to the speed of the vehicle and its load. Normally the air pressure should only be corrected when the tyres are cold. When the tyres are warm, a change in pressure should take place only when air must be pumped into the tyres.

Excessively low air pressure is one of the most common reasons for tyre wear. Tyres which are insufficiently inflated also result in difficult steering and high fuel consumption. Too high air pressure tends to make for poor riding comfort.

Be careful when parking the car next to the pavement not to damage the tyres against the pavement kerb.

SERVICING



1



2

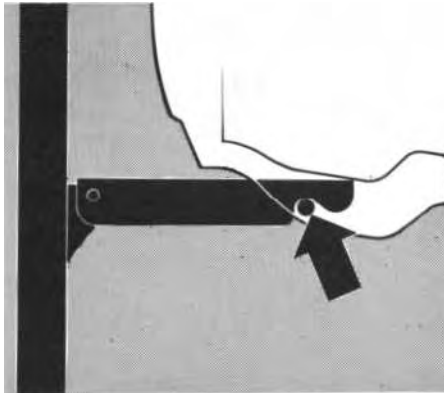

3



4

Changing a wheel

The spare wheel, jack and tool kit are stored in the luggage compartment. When the car is to be jacked up, the jack should be on level, firm ground. Avoid creeping under the car when it is jacked up since there is risk that the car might topple off the jack, particularly if the ground is soft.

Removing

1. Unscrew the wheel cap crosshead screw and remove the wheel cap.
2. Loosen the wheel nuts 1/2-1 turn with the help of the box spanner and tommy bar in the tool kit. All the nuts have right-hand threads which are loosened by turning them in an anti-clockwise direction.
3. Insert the lifting arm of the jack in the appropriate jack attachment of the wheel to be changed. Make sure the arm goes in all the way. Jack up the side of the car far enough to lift the wheel off the ground.
4. Unscrew the wheel nuts completely and lift off the wheel. Be careful when lifting off the wheel that the threads of the studs are not damaged. Remove the hub cap.



Fitting

1. Fit the hub cap on the wheel rim from the inside according to the above picture and clean the contact surfaces between wheel and hub.
2. Lift on the wheel. Tighten the nuts until the wheel makes good contact with the flange.
3. Lower the vehicle and tighten the nuts alternately.
4. Fit the wheel cap.

Do not rotate a raised rear wheel if the car is fitted with a limited slip differential as this will also move the other rear wheel on the ground, so that the car may topple off the jack.

BODY

39 Washing

The car should be washed often since such things as dirt, dust, dead insects, tar spots, etc. usually adhere firmly to the body and may damage the paintwork. Washing also helps to counteract rusting.

When washing the car, make sure that it is not exposed to direct sunlight since this can cause drying patches. Begin by softening up the dirt on the underside of the body with a jet of water and use if necessary a soft brush. Then rinse down the whole body with a light jet until the dirt has loosened up. After this, wash off the dirt with a sponge using plenty of water. Use preferably lukewarm but not hot water. A detergent can be used to facilitate washing. Special detergents are now available on the market - even dish-washing fluids can be used. A suitable mixture is about 5-10 cl (1.5 -3.5 fl. ozs.) of fluid dishwasher to 10 dm³/litres (2.6 US galls = 2.2 Imp. galls) of water. Asphalt spots and tar pittings can easily be removed with white spirit or equivalent, but this should be done after the washing.

When a detergent is used, the car should be well rinsed down with clean water afterwards. Begin with the roof of the car and work down the body. Then dry carefully with a soft cleaning leather. Use different leathers for the windows and the remainder of the car, otherwise using the same leather can leave greasy smears on the windows. When washing the car, remember to clean

the draining holes in the doors and bottom sills.

Note. When washing the car in a washing bay, the vent control should be closed. In certain cases, the air intakes for the car heater should be covered.

Chromed parts

Chromium-plated and anodized parts should be washed with clean water as soon as they become dirty. This is particularly important if you drive on gravel roads which are treated with chemicals to keep the dust down or in the winter when salt is used to melt the snow. After the car has been washed, apply wax or anti-rust preparation.

SERVICING

40 Polishing (waxing)

The vehicle does not need polishing until the surface finish begins to lose its lustre and normal washing is no longer sufficient to make it shine again and remove the layer of dirt on the surface. Under normal conditions it is sufficient to polish the vehicle a couple of times a year on condition that it is carefully looked after and thoroughly washed as soon as it has become dirty or dusty. Before the vehicle is polished, it should be carefully washed and dried to avoid scratches on the paintwork.

Before applying wax, make sure that the surface is absolutely clean.

It may often be necessary to use white spirit for cleaning.

Waxing should neither be considered as a substitute for polishing nor as a necessary protection for the paintwork against unfavourable weather. For the most part waxing is not necessary until one year after delivery of the car.

41 Cleaning the upholstery

Leather upholstery can be cleaned with a damp cloth, eventually with a mild soap solution.

For more difficult spots, consult an expert for choice of cleaning agent.

Fabric-plastic is washed with a mild soap solution or, in more difficult cases, with some household detergent.

Petrol, white spirit, carbon tetrachloride or similar cleaning agent must not be used on leather upholstery, since these are harmful both to the leather and fabric-plastic.

42 Rustproofing

Your Volvo is rustproofed at the factory. Inspection and any touching-up of the rustproofing should be done at regular intervals and at least once a year. The enclosed body sections should also be rustproofed by means of spray application at least once a year.

If any touching-up of the rustproofing is necessary, this should be done immediately to prevent moisture from seeping in and consequently damaging it.

Cleaning the floor carpets

The floor carpets should be hoovered or swept clean regularly. Especially during the wintertime, they should be taken out and dried. Spots on textile carpets can be removed with a mild detergent.

SERVICING

TOUCHING-UP PAINTWORK DAMAGE

Damage to the paintwork requires immediate attention if rusting is to be avoided. Always make a habit, therefore, of checking the finish regularly and touch-up if required for example when about to wash your car. The touching-up of any damage to the synthetic finish imposes great demands on workshop equipment and skill. Any such damage, therefore, should be carried out by a Volvo workshop. Minor damage caused by flying gravel, etc., can be attended to by yourself. Touch-up lacquers are available in tins or spray bottles at your local Volvo dealer.



NOTE! To ensure you get the right colour, use the colour code on the type plate in the engine compartment.

If the damage has not penetrated to the metal and the surrounding paintwork is in good condition, lightly scrape off the dirt and apply the appropriate paint.

If the damage has penetrated to the metal proceed as follows:

1. Scrape the damaged surface clean and bevel off the edges of the paintwork with a penknife or similar.
2. Stir the primer well and apply it to the damaged spot with the help of a fine brush or match stick.
3. When the primer has dried apply the surface lacquer with a brush. Make sure that the lacquer has been well stirred and apply light coats several times and allow the coat to dry between each application.
4. With scoring, etc., proceed as above, but it may be necessary to mask off the undamaged paintwork.

NOTE! Before carrying out any touching-up, the car should be well cleaned and dry and have a temperature not less than +15 °C (59 °F).

SERVICING

BEFORE A LONG-DISTANCE TRIP

If you are thinking of taking a long journey with your car, you should have it checked at a Volvo workshop. You will enjoy your journey better if you know that your car is in perfect trim. Irritating incidents can be avoided as well as expensive and time-absorbing stoppages. Wherever you go there should be a Volvo workshop within easy call to attend to your car if required. However, it is always a good idea before making a trip to ensure that, at least on a minor scale, you have with you a comprehensive touring kit. This is particularly the case if you anticipate widely varying conditions as regards climate, roads and the prevalence of much dust. Many workshops stock special kits for this purpose. Remember when filling up with fuel to observe the existing fuel recommendations.

If you prefer to lock over your vehicle yourself, the following tips are worthwhile noting:

1. Check the brakes, front wheel alignment and steering gear.
2. Check the engine and drive units with regard to fuel, oil, coolant leakage.
3. Examine the tyres carefully. Replace worn tyres.
4. Check that the engine is running satisfactorily and that fuel consumption is normal.
5. Examine the state of charge of the battery and clean terminals.
6. Check over the tool equipment and spare wheel.
7. Check the lighting.

COLD WEATHER

When cold weather is on the way, it is time to think of the winter servicing of your car. The first night of frost can come as an unpleasant surprise unless preventive precautions have been taken.

Engine cooling system

A good quality anti-freeze should be used all the year round. Thus, the cooling system should always contain water plus anti-freeze and rust inhibitor, even during the summer.

Concerning coolant changes, see page 47. Experience has also shown that extremely weak anti-freeze solutions (10-25 %) are very unfavourable from the point of view of rust protection. For this reason, the quantity of anti-freeze should amount to about 50 % of the coolant, that is, 6.2 dm³ (litres) (11 Imp. pints), this lowering the freezing point to -35 °C (-31 °F).

Radiator spirit is not recommended as anti-freeze agent since it evaporates at normal engine temperature.

SERVICING

Engine fuel system

During the wintertime with large variations in temperature, condensation water forms in the fuel tank and can impair the running of the engine. This can be eliminated by adding suitable carburettor spirit (but not methylated spirit) to the fuel. Add spirit before filling the fuel tank with fuel. Also, there is less risk of condensation water forming if the tank is kept well-filled.

Electrical system

The electrical system in the vehicle is subjected to greater stresses during the winter than during the warm summer months. The lighting and starter motor are used more and since the capacity of the battery is also considerably lower at low air temperature, the state of charge must be checked more often and, if necessary, the battery charged. If the battery voltage is excessively low, there is risk of the battery, being damaged by frost.

Windscreen washer

Just as anti-freeze is added to the cooling system during the winter to prevent frost damage, anti-freeze should also be added to the water container for the windscreen washers. This is particularly important because the windscreen during the winter frequently becomes dirty and is often splashed with water which rapidly freezes and thus necessitates the frequent use of the windscreen washer and wipers. Your Volvo dealer can supply you with suitable anti-freeze for this purpose.

Engine lubricating system

During the winter multigrade oil or engine oil SAE 10 W should be used for the engine lubricating system. At very low temperatures (below $-20^{\circ}\text{C} = -4^{\circ}\text{F}$) multigrade oil SAE 5 W-20 is recommended. These oils reach the lubricating points in the engine more easily at low temperature and also facilitate cold starting. See page 41.

Brake system

During very cold weather the brakes are subjected to splash and condensation water which can result in the parking brake freezing up if left on. When you park the car, do not apply the parking brake but engage first gear or reverse and if possible place blocks behind the wheels. See also page 27.

Anti-freeze for door locks

A frozen door lock is one the most irritating things that can happen to a car owner. Many valuable minutes early in the morning can be wasted warming up keys and melting ice in locks. Remember this in good time and lubricate the locks in advance with some suitable anti-freeze agent. Such agents are now available in small handy tubes which can easily find room in a handbag or coat pocket.

FAULT TRACING

The information given below is only intended to serve as a guide in localizing and temporarily correcting minor faults. After having carried out any such measures, have them looked over by an experienced mechanic.

The engine does not start although starter motor turns it over at normal speed

1. Check to make sure there is fuel in the tank.
2. Check to make sure the fuel pump is functioning properly. This is done by turning the ignition key to driving position. This will run the pump for 1 to 1.5 seconds. If the pump does not function, check to make sure that the pump fuse is not blown.
3. Attn. Do not touch the accelerator pedal if the engine is cold.
If the engine is hot, start it with the accelerator pedal depressed halfway. Avoid repeated short attempts at starting. Instead, let the starter motor run a little longer (max. 15-20 seconds) at each try.

4. With damp weather, when flashover is possible, wipe the park plug isolators clean. Release the distributor cap and wipe it dry.
Check to make sure that the ignition leads are properly fitted in the distributor head and ignition coil.
5. Check to make sure that all contacts for sensors and injectors are properly fitted.
6. If the engine turns over without starting, there may be too much fuel in the cylinders, with damp plugs as a result. Screw out the plugs and wipe them dry. Check the electrode gap.

If the engine misfires, the reason can be:

1. That one of the ignition leads has loosened in the distributor cover or from the spark plug.
2. That one or more of the spark plugs are coated with soot or oiled up, in which case the plug concerned should be cleaned or changed and the spark plug gap adjusted.
3. That the distributor cap and rotor arm are cracked or damaged.

4. That one of the ignition leads is in poor condition.
5. That the ignition point gap in the distributor is insufficient or non-existent.
6. That the ignition points are badly burned.
7. Fault in fuel system's electronic unit. This must be checked by a workshop.

How to start your car on a downgrade

Switch on the ignition, engage 3rd gear or even 4th and let the car roll downwards with the clutch pedal depressed. When the speed is up to 15-20 kmph (9-12 mph) and not before, release the clutch pedal slowly. Being towed: Secure the towline to the towing loop. The car is towed at an even speed in 2nd gear. Try starting as suggested in the previous paragraph.

Warning! Do not attempt to start a car with automatic transmission by rolling it downhill or towing it. See recommendations on page 26.

SPECIFICATIONS

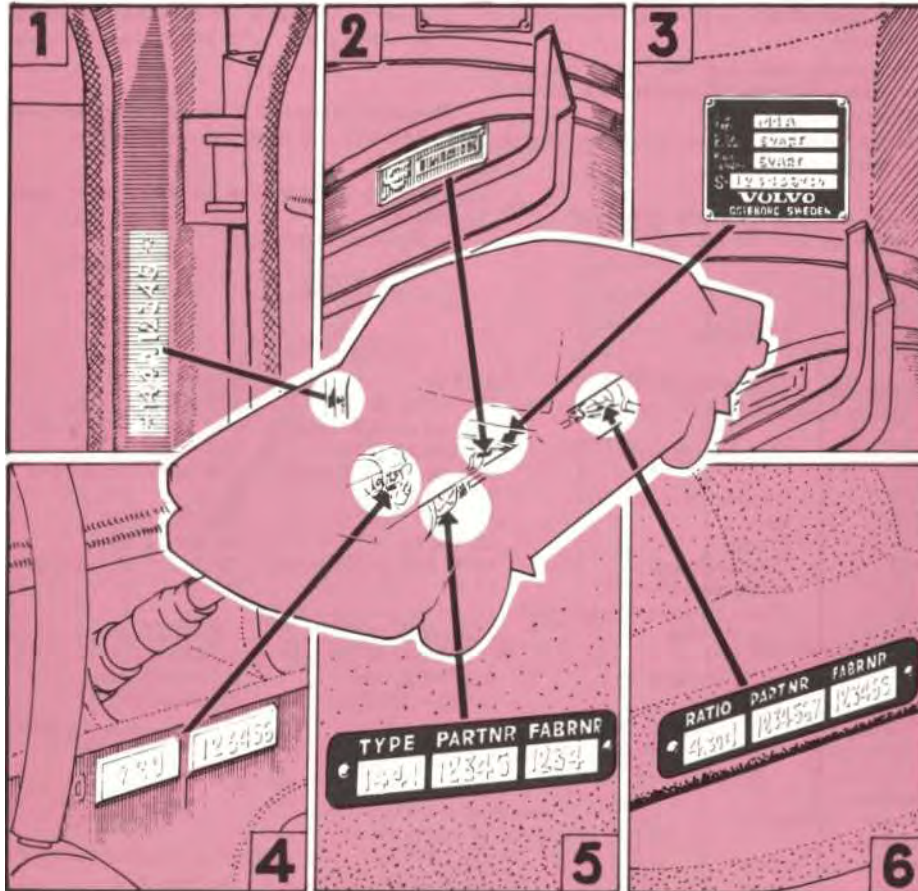

Type designations

In all correspondence with the dealer concerning your vehicle and when ordering parts, the type designation, chassis and engine number should always be quoted.

1. Type and model year designation (A) as well as chassis number:
Stamped on right door pillar and on plate mounted on stay for rear wall of luggage compartment.
2. Body number.
3. Vehicle type designation, code number for colour and upholstery:
On bulkhead.
4. Type designation, serial number and part number of engine
Stamped on engine left-hand side.
5. Type designation, serial number and part number of gearbox
Underneath gearbox.
6. Final drive reduction ratio, part number and serial number:
On a plate on left-hand side of final drive.

SPECIFICATIONS

NEW MEASUREMENT UNITS

For some time technicians have endeavoured to find an internationally standardized measurement system. In 1960, such a system was established and was called SI (Système International d'Unités). To a great extent it is based on the previous system except that the units are uniform, that is, no conversions are required. The SI system is now

being applied both in Swedish and European industries.

The new SI units are inserted in this manual. The old units, however, are given in brackets.

Of the new units, the following concern the owner's manual:

Power is indicated in kW (kilowatt)
previous unit hp (horsepower)

Torque is indicated in Nm (Newtonmetre)
previous unit kpm/lbft (kilopondmetre/
footpond)

Speed is indicated in r/s (revs per second)
previous unit rpm (revs per minute)

Capacity is indicated in dm³ (cubic decimetre)
previous unit l (litre)

MEASUREMENTS AND WEIGHTS

Note. Variations can occur due to regulations on different market.

Length	487 cm (192")
Width	171 cm (67,1")
Height	145 cm (57.0")
Wheelbase	272 cm (107")
Ground clearance, fully laden	12.5 cm (4.9")
Track, front	135 cm (53.2")
rear	135 cm (53.2")
Turning circle, between kerbs	10.3 m (33.8 ft)
Kerb weight	1470—1500 kg (3235—3300 lb) depending on vehicle type
Permissible total weight	1880 kg (4140 lb)
Permissible load (without driver)	380—410 kg (835—900 lb) depending on vehicle type
Permissible axle pressure, front	900 kg (1980lb)
rear	1015 kg (2230 lb)
Permissible roof rack load	100 kg (220 lb)
Max. permissible trailer weight	1200 kg (2640 lb)

ENGINE

Type designation	B 30 E	B 30 F
Output DIN	118 kW at 92 r/s (160 hp at 5500 rpm)	107 kW at 92 r/s (145 hp at 5500 rpm)
Max. torque DIN	230 Nm at 42 r/s (170 lbft at 2500 rpm)	216 Nm at 42 r/s (160 lbft at 2500 rpm)
Number of cylinders	6	6
Bore	88.9 mm (3.50")	88.9 mm (3.50")
Stroke	80 mm (3.15")	80 mm (3.15")
Displacement	2.978 dm ³ (2.978 litres)	2.978 dm ³ (2.978 litres)
Compression ratio	10.0:1	8.7:1
Valve clearance, warm and cold, inlet	0.50—0.55 mm (0.020—0.022")	0.50—0.55 mm (0.020—0.022")
exhaust	0.50—0.55 mm (0.020—0.022")	0.50—0.55 mm (0.020—0.022")
Idling speed (warm engine)		
standard gearbox	15 r/s (900 rpm)	15 r/s (900 rpm)
automatic transmission	13 r/s (800 rpm)	13 r/s (800 rpm)

SPECIFICATIONS

Output and torque diagram

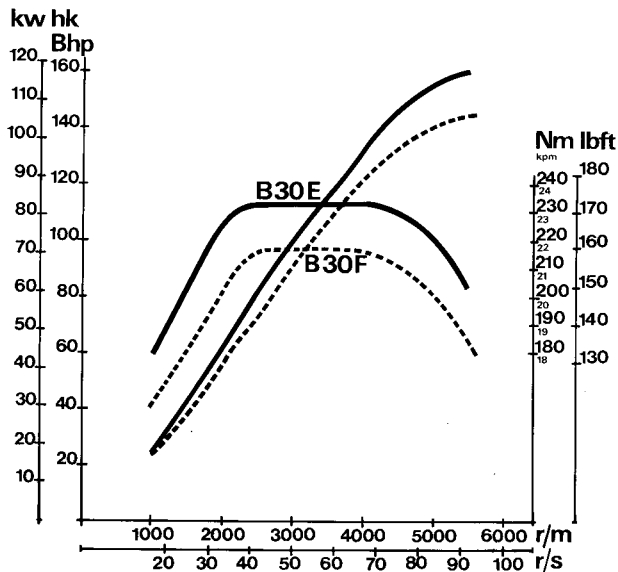

Cooling system

Type	Closed system
	Positive pressure
	(approx. 0.7 kp/cm ² = 10 psi)
Thermostat, begins to open at	82° C (180° F)
fully open at	90° C (195° F)
Fan belt, designation	HC-38×888

Ignition system

Firing order	1-5-3-6-2-4
Ignition setting	
stroboscope setting	
(vacuum governor disconnected)	
B 30 E	10° BTDC at 12—13 r/s (700—800 rpm)
B 30 F	10° BTDC at 10—13 r/s (600—800 rpm)
Spark plugs, B 30 E	Bosch W 225 T 35*
Spark plugs, B 30 F	Bosch W 200 T 35*
spark plug gap	0.7—0.8 mm (0.028—0.032")
tightening torque	34—39 Nm (25—29 lbft)
Distributor, direction of rotation	Anti-clockwise
ignition points gap	0.25 mm (0.010")
	* or corresponding

Electrical system

Voltage	12 V
Battery, type	Tudor 6 EX4 F o.p.*
capacity	60 Ah
electrolyte, specific gravity	1.28
recharged at	1.21
Alternator max. output	770 W
max. current	55 A
Starter motor, output	0.74 kW (1hp)
	* or corresponding

SPECIFICATIONS

Bulbs 12 volts	Power	Socket	Number
Headlights	60/55 W	H4	2
Foglights	55 W	P 14.5 s	2
Parking lights, front	5 W	Ba 15 s	2
Turn indicators, front and rear	32 cp	Ba 15 s	4
Tail lights	5 W	Ba 15 s	2
Brake stop lights	32 cp	Ba 15 s	2
Reversing lights	32 cp	Ba 15 s	2
License plate light	5 W	S 8.5	2
Interior lighting	10 W	S 8.5	1
Glove locker light	2 W	Ba 9 s	1
Engine compartment light	18 W	S 8.5	1
Instrument panel light	2 W	W 2.2 d	3
Lighting, control panel	1.2 W	W 1.8 d	3
shift positions, aut. trans.	1.2 W	W 1.8 d	1
Warning/control lamps:			
charging	1.2 W	W 1.8 d	1
turn indicators	1.2 W	W 1.8 d	2
brakes	1.2 W	W 1.8 d	2
headlights	1.2 W	W 1.8 d	1
oil pressure	1.2 W	W 1.8 d	1
overdrive	1.2 W	W 1.8 d	1
emergency warning flashers	1.2 W	W 1.8 d	1
elec. heated rear window	1.2 W	W 1.8 d	1
seat belts	1.2 W	W 1.8 d	1
bulb integrity sensor	1.2 W	W 1.8 d	1

Fuses (fusebox, in coupé)

6	5 A
4	8 A
2	16 A

Fuses (fusebox, in engine compartment)

2	8 A
---	-----

POWER TRANSMISSION

Clutch

Release lever free travel approx. with right-hand drive	4—5 mm ($\frac{3}{16}$ " 2—3 mm ($\frac{3}{32}$ "
---	--

Gearbox

Type designation	M 400	M 410	BW 35	
Reduction ratios:				
1st speed	3.54:1	3.54:1	2.39:1	} × the con- verter ratio
2nd speed	2.12:1	2.12:1	1.45:1	
3rd speed	1.34:1	1.34:1	1:1	
4th speed	1:1	1:1	—	
with overdrive	—	0.797:1	—	
Reverse	3.54:1	3.54:1	2.09:1	

Rear axle

Type

Reduction ratio	Hypoid bevel gear		
	M 400	M 410	BW 35
Engine B 30 E	3.54:1	3.54:1	3.31:1*
Engine B 30 F	3.73:1	3.73:1	3.31:1

* In some markets 3.54:1 alt. 3.23:1.

SPECIFICATIONS

Vehicle speed, kmph (mph) at 17 r/s (1000 engine rpm)

Final drive	3.54:1	3.73:1
1st speed	9.5 (5.9)	9.5 (5.9)
2nd speed	16.5 (10.3)	15.5 (9.6)
3rd speed	25.5 (15.9)	24.5 (15.2)
4th speed	34.5 (21.6)	33.0 (20.5)
4th speed + overdrive	42.5 (36.5)	41.0 (25.5)
Reverse	9.5 (5.9)	9.5 (5.9)

FRONT WHEEL ALIGNMENT

The alignment values apply to an unladen car but include fuel, coolant and spare wheel.

Toe-in	2—5 mm ($\frac{1}{8}$ "
Camber	0 to + $\frac{1}{2}^{\circ}$
Caster	+ 1° to + 2°
King pin inclination	7.5°

WHEELS AND TYRES

Rim size	5½ J 15 F.H.
Tyre size	175 HR 15

Air pressure cold tyres, kp/cm ² (psi)	Front	Rear
1—3 persons	1.7 (25)	1.8 (26)
Fully loaded	1.8 (26)	2.1 (30)

For sustained high speed driving, the pressure must be increased by 0.3 kp/cm² (4 psi). However, total pressure must not exceed 2.6 kp/cm² (37 psi).

CAPACITIES

Fuel tank	60 dm ³ /litres (13.2 Imp.galls)
Cooling system	12.4 dm ³ /litres (2.7 Imp.galls) (of which expansion tank 1.5 dm ³ /litres = 3.2 Imp.pints)

Oil capacity,	
engine, at oil change	5.2 dm ³ /litres (9.0 Imp. pints)
incl. oil filter	6.0 dm ³ /litres (10.6 Imp. pints)
transmission (M 400)	0.6 dm ³ /litres (1.1 Imp. pints)
(M 410)	1.5 dm ³ /litres (2.5 Imp. pints)
(BW 35)	8.2 dm ³ /litres (14.4 Imp. pints)
rear axle	1.6 dm ³ /litres (2.8 Imp. pints)
power steering	1.1 dm ³ /litres (1.9 Imp.pints)

TOOL KIT

Box spanner for wheel nuts and spark plugs
Tommy bar for box spanner
Philips screwdriver
Open-end spanner

LUBRICATING CHART

Symbols



Engine oil
 Grade: For Service SE
 (earlier designation MS)
 Viscosity: Multigrade
 See also page 41

Rear axle oil
 Grade: MIL-L-2105 B
 Viscosity: See page 43

Brake fluid
 Grade: SAE J 1703
 SAE 70 R3
 can also be used

Special lubricants
 See resp. note

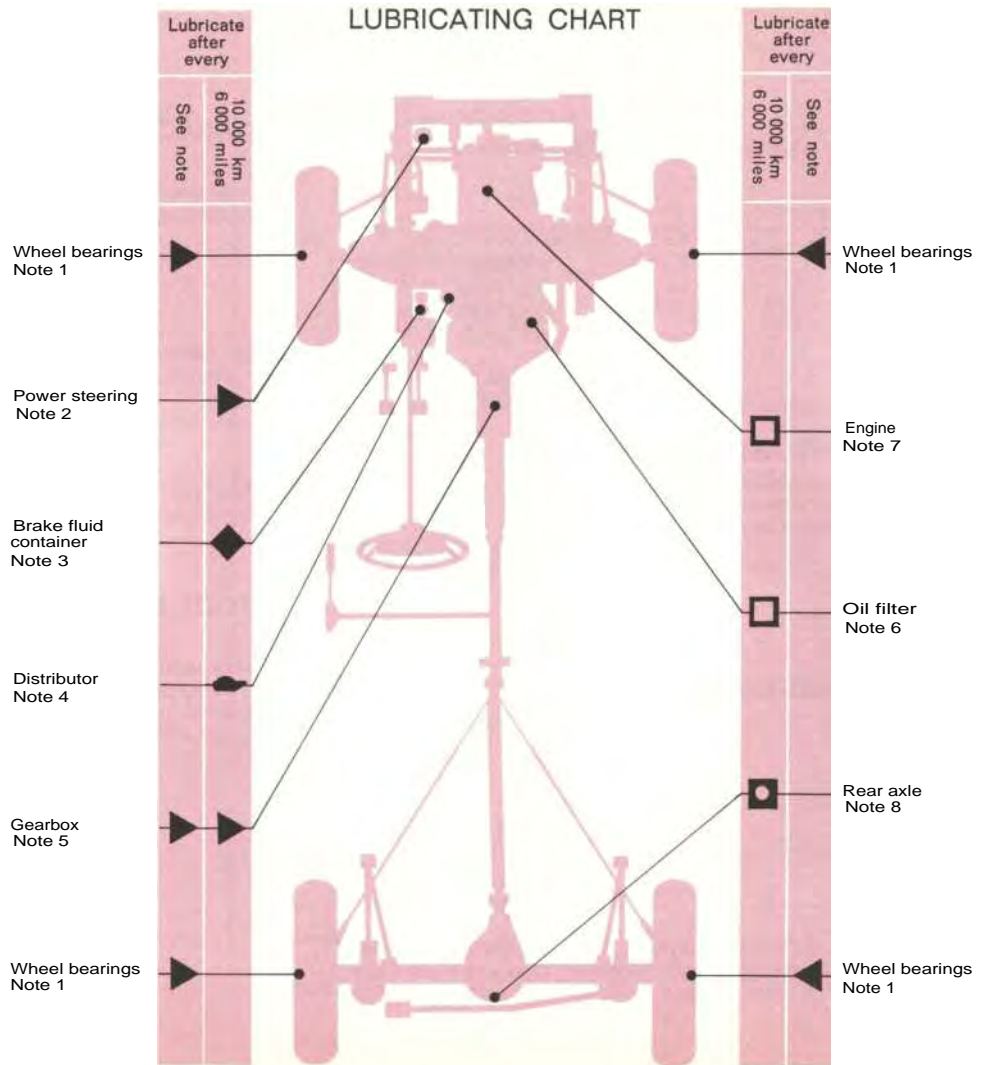
Light engine oil



LUBRICATING CHART

Notes to lubricating chart

Note 1. The wheel bearings are packed at the factory with a special type of grease intended to last the entire lifetime of the bearings. In connection with any workshop operations involving uncovering the wheel bearings, the bearings should be cleaned and then lubricated with high-class, durable grease according to the instructions in the service manual. Except on the above occasion, subsequent adding or changing of lubricant is not required.

Note 2. Power steering oil : Check that the oil level in the power steering oil container is 5-10 mm (5/16") above the level mark. Use Automatic Transmission Fluid. Type A or Dexron.

Note 3. Check that the fluid reaches up to the MAX mark. (For right-hand drive, check also clutch fluid level.)

Note 4. Lubricate the felt wick under the rotor and fill a few drops of light engine oil into the lubricating cup.

Note 5. Check every 10 000 km (6 000 miles) that the oil reaches up to the filler plug. Concerning oil change, see page 42.

NOTE. The type of gearbox (standard or automatic) will decide the type of lubricant to be used.

Note 6. Change the oil filter every 10 000 km (6 000 miles). See page 44.

Note 7. Check the oil level when filling the tank. Concerning oil changing, see page 41.

Note 8. Check every 10 000 km (6 000 miles) that the oil reaches up to the filler plug. Concerning lubricant for rear axle with differential lock, see page 43.

Oil capacities

Engine, oil change quantity incl. oil filter	approx. 5.2 dm ³ /litres (9.0 Imp. pints) approx. 6.0 dm ³ /litres (10.6 Imp. pints)
Gearbox M 400	approx. 0.6 dm ³ /litres (1.1 Imp. pints)
M 410	approx. 1.4 dm ³ /litres (2.5 Imp. pints)
BW 35 (automatic)	approx. 8.2 dm ³ /litres (14.4 Imp. pints)
Rear axle	approx. 1.6 dm ³ /litres (2.8 Imp. pints)
Power steering	approx. 1.1 dm ³ /litres (1.9 Imp. pints)

WHEN FILLING THE TANK

Check to make sure you get the right octane, that is.

B 30 E engine: minimum 97 octane

B 30 F engine: minimum 91 octane

Also check:

Oil level in engine

The level should be between the marks on the dipstick.

If necessary top up with multigrade oil. The distance between the marks on the dipstick corresponds to about 2 dm³/litres (2 qts.)

Coolant level

The level should be between the MAX and MIN marks on the expansion tank.

If necessary top up with a mixture of 50 % anti-freeze and 50 % water.

Water level in windscreen washer container

The windscreen washer container should always be well-filled. (During the winter with water and anti-freeze.)

Brake fluid level

Without taking off the cap, check that the level is above the MIN mark.

If necessary top up with brake fluid SAE J 1703.



Every other time the following should also be checked:

Acid level in battery

The level should be 5-10 mm (3/8") above the cell plates. If necessary add distilled water.

Pressure in tyres

Recommended tyre pressures:

Air pressure, cold tyres, kp/cm ² (psi)	front	rear
1-3 persons	1.7 (25)	1.8 (26)
Fully loaded	1.8 (26)	2.1 (30)

For sustained high speed driving, the pressure must be increased by 0.3 kp/cm² (4 psi). However, total pressure must not exceed 2.6 kp/cm² (37 psi).

Sometimes it may be necessary to adjust the windscreen washer nozzles.

Each jet should strike the windscreen 10-20 cm (4—8") from the upper edge of the windscreen and about 30 cm (12") from the respective windscreen pillar.



AB VOLVO • GÖTEBORG, SWEDEN